

VIDEO SOUNDER

AVS-107

OPERATION MANUAL

SITEX[®]

DOC NO. AVS-107

IMPORTANT NOTICE

Before attempting to install and operate your unit, we recommend you read through this operation manual.

After reading the operation manual, if you still do not understand about the operations and installations of your unit, we recommend you contact your dealer or SI-TEX Marine Electronics Customer Service.

CAUTION

Keep away from heat.

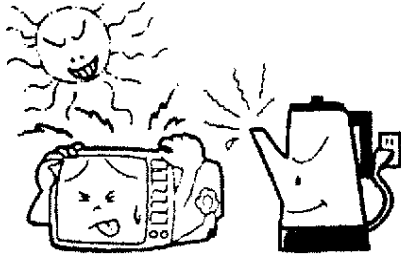

- Keep your video sounder away from any heated object or direct sunlight.
- Do not operate with cover on, otherwise trouble may occur.

Keep away from magnetic object.

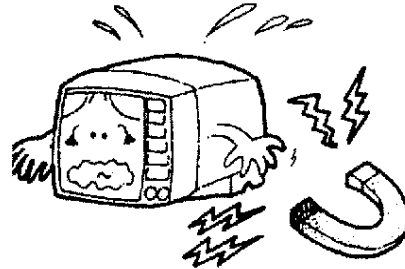

- Keep your video sounder away from any magnetic object to prevent the screen from being affected by misconvergence phenomenon.

Keep away from water.

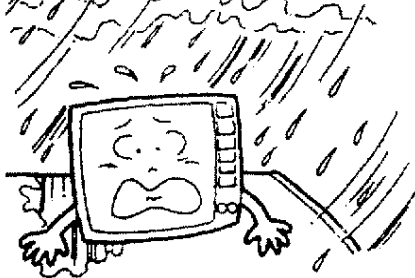

- Keep your video sounder away from splashing water or rain. If the equipment is not used for a long time, turn the power on and operate for a while to dry up the interior.

Connect transducer correctly.

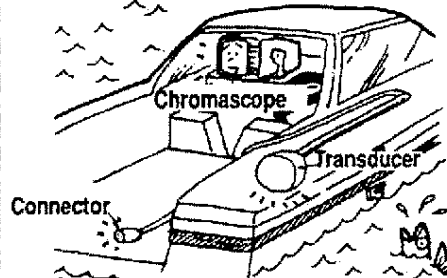

- Connect your video sounder to the transducer in the water before turning the power on. If the transducer is not connected, or if the signal is transmitted in the air, the internal circuits and transducer may be damaged.

Keep transducer surface clean.

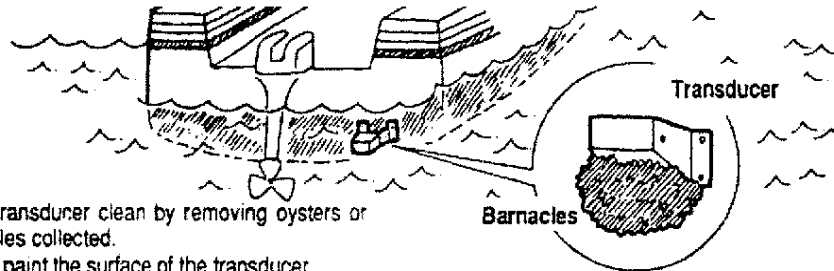

- Keep transducer clean by removing oysters or barnacles collected.
- Do not paint the surface of the transducer.

Welcome to SI-TEX AVS-107

The 6-inch AVS-107 is a "state of the art" fishing aid. It is exceptionally easy-to-read, while offering professional use feature and performance. The AVS-107 determines fish or fish school location under your boat on the screen to help you find where to fish. Read this manual carefully before turning on the power.

Table of Contents

IMPORTANT NOTICE

INTRODUCTION	1
Names and Function of Control Panel	2
Reading Screen Images	3
Reading echo sounder screen images.....	3
NORMAL RANGE mode screen	3
ZOOM RANGE mode screen	4
BIG NUMBER screen	4
GETTING STARTED	
Displaying Normal Mode Screen	5
Turning power on	5
Adjusting screen brightness (BRT)	5
Selecting a depth range.....	6
Adjusting gain	7
Selecting image advance speed	8
Displaying Zoom Mode Screen	9
Selecting zoom range	9
Selecting a screen top depth of zoom area.....	10
Setting Bottom Alarm	11
Setting upper alarm	11
Setting lower alarm	12
Setting Fish Alarm	13
Storing Event Data	15
Displaying Big Number Mode Screen	16
Opening MENU Display	17
Eliminating interference noise	18
Eliminating undesired colors.....	18
Changing presentation mode	18
Displaying boat position when a navigator is interfaced	19
Displaying heading or course data when DC-400 is interfaced	19
Selecting unit of boat speed	20
Selecting unit of water temperature.....	20
Resetting trip mileage.....	20
Clearing event data.....	21
Returning to echo sounder screen	21

Opening INITIAL Display	22
Correcting boat speed and trip mileage	23
Selecting unit of measure.....	23
Interfacing with navigator or DC-400 fluxgate compass	24
INSTALLATION	
Transducer Installation and Maintenance	25
Speed Sensor - installation and maintenance	25
Cleaning Transducer	25
Saltwater maintenance	25
Transom Mount Transducer Mounting Procedure	26
Improper Transom Mount Transducer Installation	28
Thru-hull Transducer Mounting Procedure	29
Outlines and dimensions	29
Installation	30
In case of the bottom hull with a deadrise	31
Installing procedure	31
Regarding the water plug	33
Mounting Video Sounder	34
Dimensions and weight	34
Installing the mounting bracket	34
Mounting the video sounder	34
Connecting Cable Plug	35
Plug pin arrangement	35
Troubleshooting	36
SPECIFICATIONS	
Major Specifications	37
Equipment List	38
APPENDIX	
NMEA-0183 Output Format	39
Certificate of Limited Warranty	40

INTRODUCTION

Your Model AVS-107 consists of the display unit and transducer with the combination of transducer and speed/temperature sensor.

An electronic pulse signal is generated in the transmitter section of the display unit. When coupled to the transducer, this signal is converted into an ultrasonic signal and transmitted toward the bottom. The signal travels through the water until it strikes an object or the bottom. It is reflected back, hits the transducer surface, and is reconverted into an electronic signal in the transducer. Then it is amplified in the receiver section, processed in the main logic section, and displayed on the 6-inch CRT screen.

When your boat travels from point A to point B as shown in Figure 1, the beam of the transducer installed on your boat shows a cross-sectional view in the water.

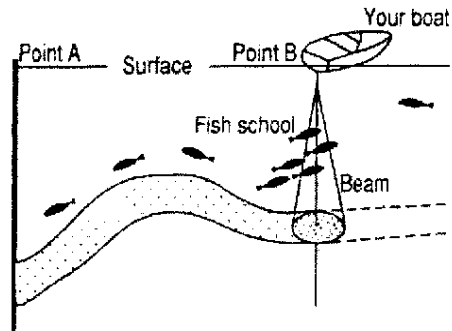

Figure A

Figure B indicates a cut-away view of the actual beam. The bottom contour is geographically displayed and will remain as your boat moves. Your video sounder is designed to accurately display fish, bottom, and underwater structure on a 6-inch CRT screen.

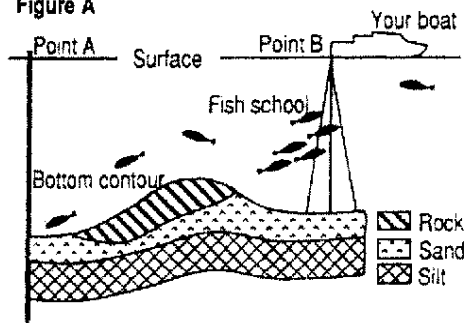

Figure B

Per Figures A and B, the bottom, which is being passed over currently, appears at the right of the screen. The display moves to the left side as new readings in the sequence appear.

While your boat travels from point A to point B, your video sounder makes the image history on the screen as shown in Figure C.

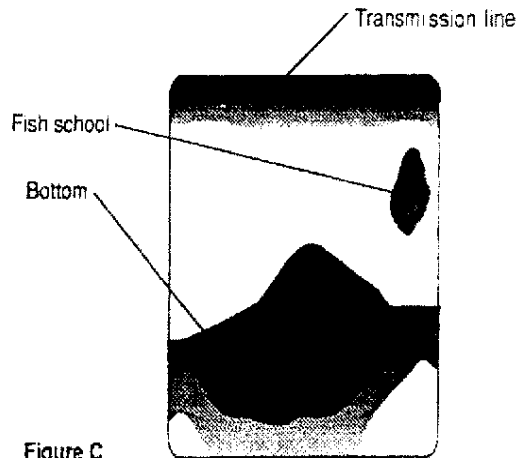
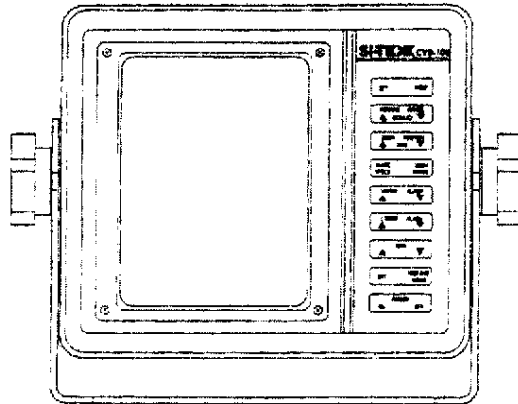

Figure C

Names and Function of Control Panels

The SI-TEX AVS-107 video sounder has a microcomputer which has been designed specially for simple operation utilizing nine keys.



MODE MENU	MODE : Alternates a video sounding screen or big number screen. MENU : Shows a menu screen.
▲ GAIN ▼	GAIN : Adjusts the receiving sensitivity of the receiver in 20 steps.
▲ RANGE (SCALE) ▼	RANGE : Selects a normal range scale.
▲ ZOOM POSN (WPT) ▼	ZOOM POSN : Selects a zoom starting position or auto zoom mode
IMAGE ZOOM SPEED RANGE	IMAGE SPEED : Selects an image advance speed in 5 steps and STOP ZOOM RANGE : Selects a zoom range. (half or quarter of the selected range).
▲ UPPER ALARM ▼	UPPER ALARM key: Designates the upper bottom alarm depth
▲ LOWER ALARM ▼	LOWER ALARM key: Designates the lower bottom alarm depth.
BRT EVENT	BRT : Adjusts the screen brightness in 10 stages. EVENT : Stores boat position, depth, and water temperature or recalls them
ON POWER OFF	POWER ON : Turns the power on. POWER OFF : Press and hold the key for a few seconds to turn off the power.

Reading Screen Images

Reading echo sounder screen images

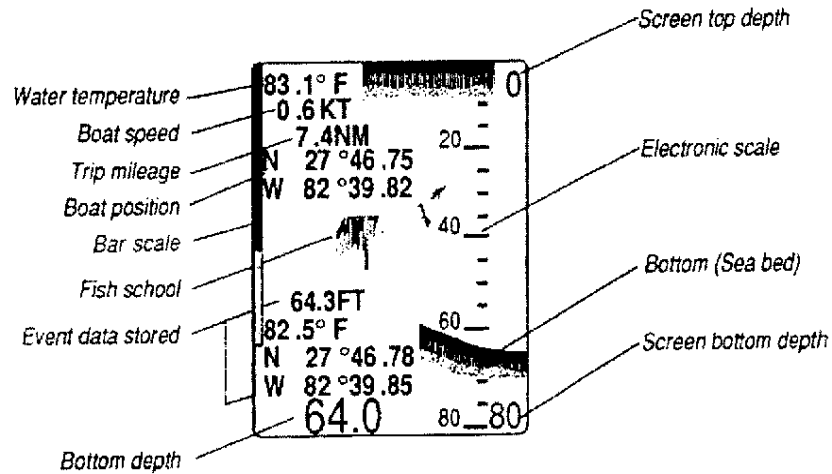

NORMAL RANGE mode screen

NORMAL RANGE: This mode detects the specified area from the surface to the designated depth. The range from screen top to the bottom is called **RANGE**. Your AVS-107 is provided with the ranges of:

- 0 to 5, 0 to 10, 0 to 20, 0 to 40, 0 to 80, 0 to 160, or 0 to 320 m (fm)
- 0 to 10, 0 to 20, 0 to 40, 0 to 80, 0 to 160, 0 to 320, 0 to 640, or 1280ft

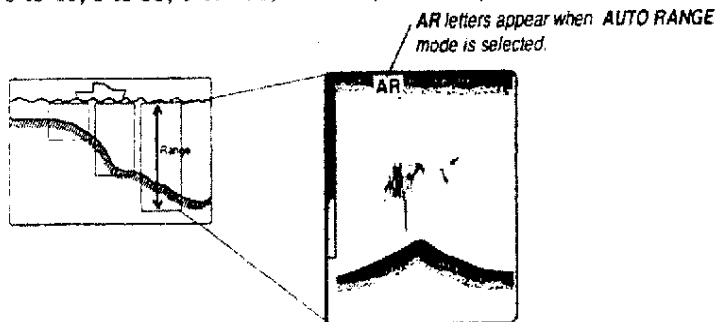

AUTO RANGE: **RANGE** is automatically selected so that the bottom is always displayed in the area between 35% and 90% from the top on the screen. The proper range is selected from the above-mentioned normal range.

ZOOM RANGE mode screen

ZOOM RANGE: This mode detects the half or quarter of the normal range on the whole screen.

Z or AZ letters appear when ZOOM RANGE or AUTO ZOOM is selected respectively

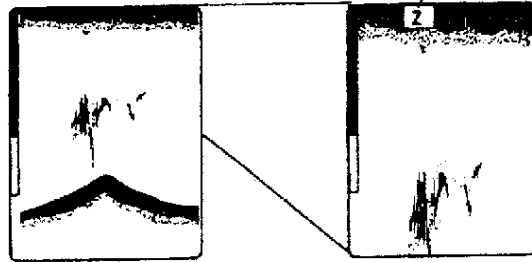

Normal range screen

Zoom range screen

In this example, upper half of the normal range is displayed on the whole screen.

The screen top depth can be selected by specifying the depth through ZOOM POSN (zoom position) key. For further information about changing screen top depth of zoom range, see *Displaying Zoom Mode Screen* on page 10 of this operation manual.

AUTO ZOOM: ZOOM RANGE is automatically selected so that the bottom is always displayed in the area between 35% and 90% from the top on the screen. The proper zoom range is selected from the above-mentioned zoom range.

BIG NUMBER screen

BIG NUMBER: This mode shows various digital data in large numerals as below:

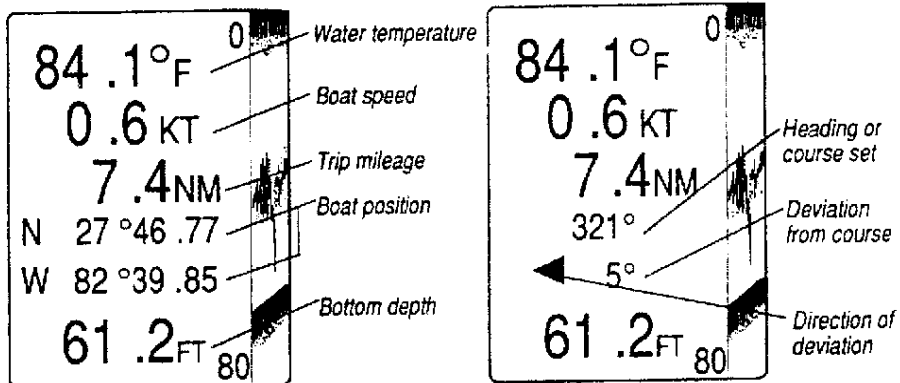

Display example with a navigator interfaced

Display example with DC-400 fluxgate compass interfaced

GETTING STARTED

Displaying Normal Mode Screen

1 Turning power on

ON POWER OFF

Press ON to turn the power on and the echo sounding image comes out from the right end of the screen.

Note

The power is turned off by pressing and holding OFF key for a few seconds.

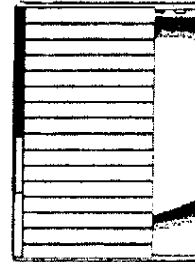
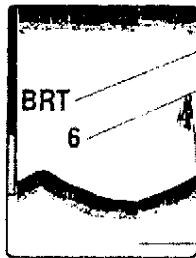
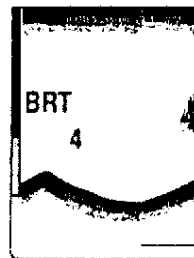

Image comes out from the right end of the screen.

2 Adjusting screen brightness (BRT)



BRT letters
Setting level



BRT EVENT

Press BRT to display BRT letters and its setting level on the screen.

BRT EVENT

While the letters are indicated, press BRT repeatedly for a comfortable screen brightness.

BRT level rotation

Every press of BRT key changes the brightness level in the following rotation:

→ 10 ▶ 9 ▶ 8 ▶ 7 ▶ 6 ▶ 5 ▶ 4 ▶ 3 ▶ 2 ▶ 1 →

Brighter

Darker

3 Selecting a depth range

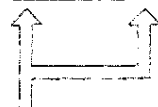
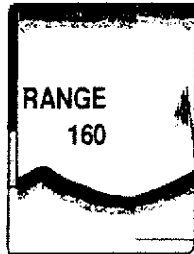
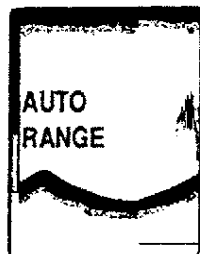

Press either the ▲ or ▼ of RANGE key to display the letters **AUTO RANGE** or **RANGE** and its setting level on the screen.

While the letters are indicated, press either the ▲ or ▼ repeatedly for selecting best suited range.

Note
 ▲: Decreases the range scale.
 ▼: Increases the range scale

RANGE selection
 Every press of RANGE key changes the displayable range

FT AUTO RANGE ◀▶ 10 ▶▶ 20 ▶▶ 40 ▶▶ 80 ▶▶ 160 ▶▶ 320 ▶▶ 640 ▶▶ 1280 ▶▶ AUTO RANGE
M/FM AUTO RANGE ◀▶ 5 ▶▶ 10 ▶▶ 20 ▶▶ 40 ▶▶ 80 ▶▶ 160 ▶▶ 320 ▶▶ AUTO RANGE

4 Adjusting gain

1. Adjust the **GAIN** level so that the bottom surface image is displayed in light amber and the tail color may be gradually changed from light to medium amber. The light amber width of the bottom surface should not be excessively wide.
2. The presentation color changes corresponding to the signal strength of the returned echo. Therefore, in case of deep sea, lake, or soft bottom contour, the bottom is not always displayed in light amber.

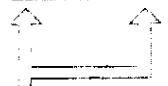
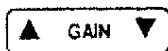
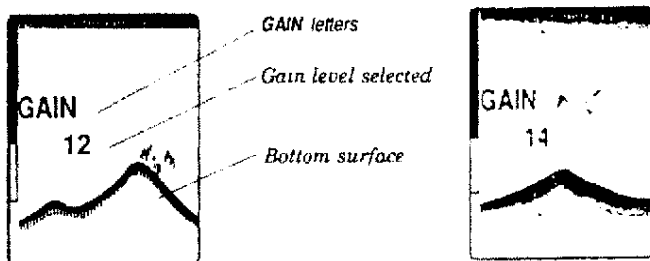

Press either the ▲ or ▼ of GAIN key to display the letters GAIN and its setting level on the screen.

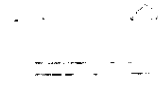
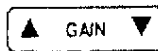

While the letters are indicated press either the ▲ or ▼ until the bottom surface is displayed in light amber.

Note

- ▲: Increases the gain.
- ▼: Decreases the gain.

GAIN level

Every press of GAIN key changes the gain level between 1 and 20

1 ↔ 2 ↔ 3 ↔ 4 ↔ 5 ↔ 6 ↔ 7 ↔ 8 ↔ 9 ↔ 10 ↔ 11 ↔ 12 ↔ 13 ↔ 14 ↔ 15 ↔ 16 ↔ 17 ↔ 18 ↔ 19 ↔ 20

Lower Higher

5 Selecting image advance speed

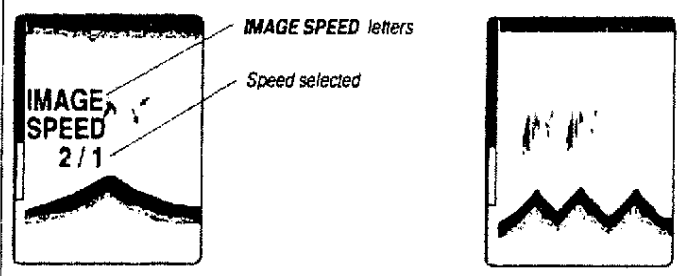

IMAGE ZOOM
SPEED RANGE

IMAGE ZOOM
SPEED RANGE

Press **IMAGE SPEED** to display **IMAGE SPEED** letters and its settings on the screen.

While the letters are indicated, press **IMAGE SPEED** for a proper speed for your particular application.

Your unit is equipped with five fixed image speeds (2/1, 1/1, 1/2, 1/4, and 1/8) plus **STOP**. The function is the number of image advances versus the number of pulses transmitted by the transducer. For example, 1/4 indicates that the image moves leftward one step for every four transmissions.

IMAGE SPEED rotation

Every press of **IMAGE SPEED** key changes the advance speed in the following rotation:

→ 2/1 ▶ 1/1 ▶ 1/2 ▶ 1/4 ▶ 1/8 ▶ STOP →

Faster ————— Slower

Displaying Zoom Mode Screen

This mode will give you the presentation of only the specified depth area. However, before you select ZOOM mode, be sure to display Normal mode screen by performing the steps on page 6.

Selecting zoom range

Note

In this example, it is assumed the depth range setting is 0 to 160 ft.

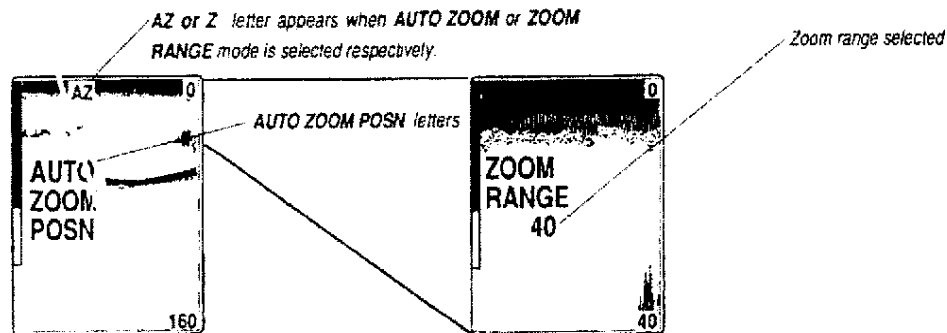

IMAGE | ZOOM
SPEED | RANGE

Press ZOOM RANGE to display the letters AUTO ZOOM POSN or ZOOM RANGE and its settings.

IMAGE | ZOOM
SPEED | RANGE

While the letters are indicated, press ZOOM RANGE to select a proper zoom range for your particular application. In this example, the ZOOM RANGE is 40 ft which is 1/4 of the depth range of 160 ft.

▲ RANGE ▼

Press RANGE arrow to return to normal mode screen.

ZOOM RANGE rotation

Every press of ZOOM RANGE key alternates the zoom range after ZOOM RANGE letters are displayed as:

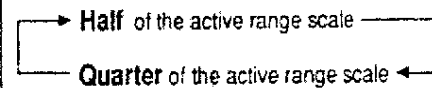

2 Selecting a screen top depth of zoom area

The screen top depth of the zoom area can be changed by performing the following procedures:

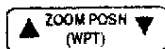
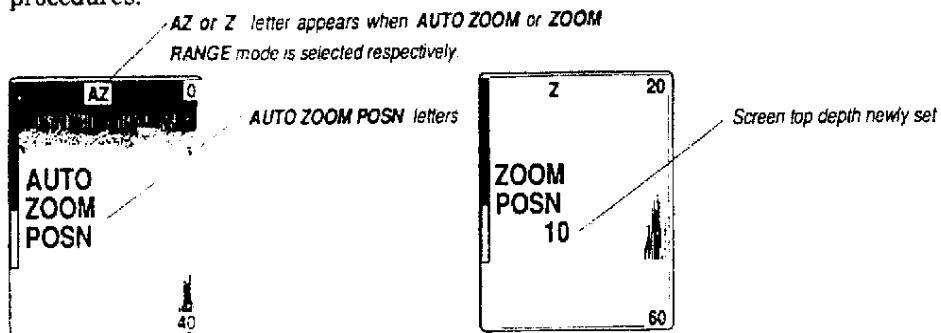

Press either the ▲ or ▼ of ZOOM POSN key to display the letters AUTO ZOOM POSN or ZOOM POSN letters and its settings.



While the letters are indicated, press either the ▲ or ▼ for selecting best suited zoom area.

Note

- ▲: Decreases the screen top depth.
- ▼: Increases the screen top depth.

Notes

- If AUTOZOOM is selected, yellow letter AZ will appear on top of the screen. When in AUTO ZOOM, the depth scales will change to keep the bottom on the screen
- If ZOOM POSITION (Manual Zoom) is selected, a yellow Z will appear on top of the screen. By pressing the ▲ or ▼ arrow of the ZOOM POSN key, desired range to zoom can be selected. In this example with the depth range of 0 to 160 ft and the zoom range of 40 ft, selectable zoom ranges are as follows:

0 - 40, 20-60, 40 - 80, 60 - 100, 80 - 120, 100 - 140, and 120 - 160 ft

Setting Bottom Alarms

Setting upper alarm

When a bottom image crosses above or below the preset alarm depth, an audible alarm sounds. Two alarms are provided with upper and lower alarms.

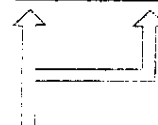
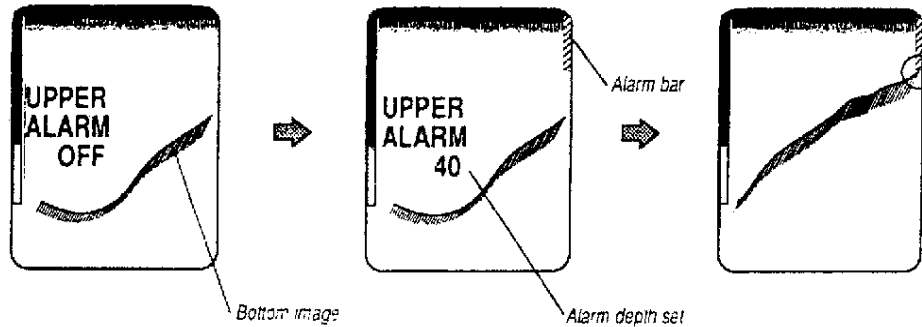

Press either the ▲ or ▼ arrow of **UPPER ALARM** key to display letters **UPPER ALARM**.



While the letters are indicated, press either the ▲ or ▼ arrow for setting the upper alarm depth. The alarm bar at the right end shows the upper alarm depth.

Intermittent audible alarm sounds when the bottom crosses above the upper alarm bar at the right end of the screen.

ARROW

- ▲: Shallower
- ▼: Deeper

Notes

- When the bottom crosses below the upper bottom alarm bar the audible alarm automatically turns off.
- When the alarm depth indicated with bar is out of screen, the alarm is not effective.
- Pressing either the ▲ or ▼ arrow of **UPPER ALARM** key turns off the alarm sound.

Setting lower alarm

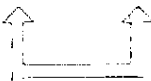
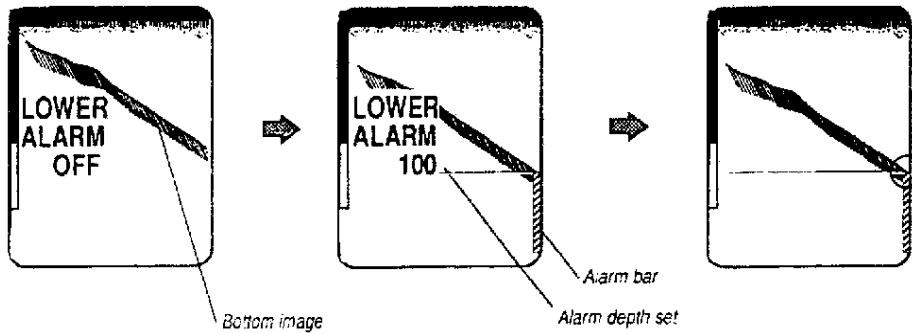

Press either the ▲ or ▼ arrow of **LOWER ALARM** key to display letters **LOWER ALARM**.

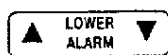

While the letters are indicated, press either the ▲ or ▼ arrow for setting the lower alarm depth. The bar at the right end shows the lower alarm depth.

Intermittent audible alarm sounds when the bottom crosses below the lower alarm bar at the right end of the screen.

ARROW

- ▲: Shallower
- ▼: Deeper

Notes

- When the bottom crosses above the lower bottom alarm bar the audible alarm automatically turns off.
- When the alarm depth indicated with bar is out of screen, the alarm is not effective.
- Pressing either the ▲ or ▼ arrow of **LOWER ALARM** key turns off the alarm sound.

Setting Fish Alarm

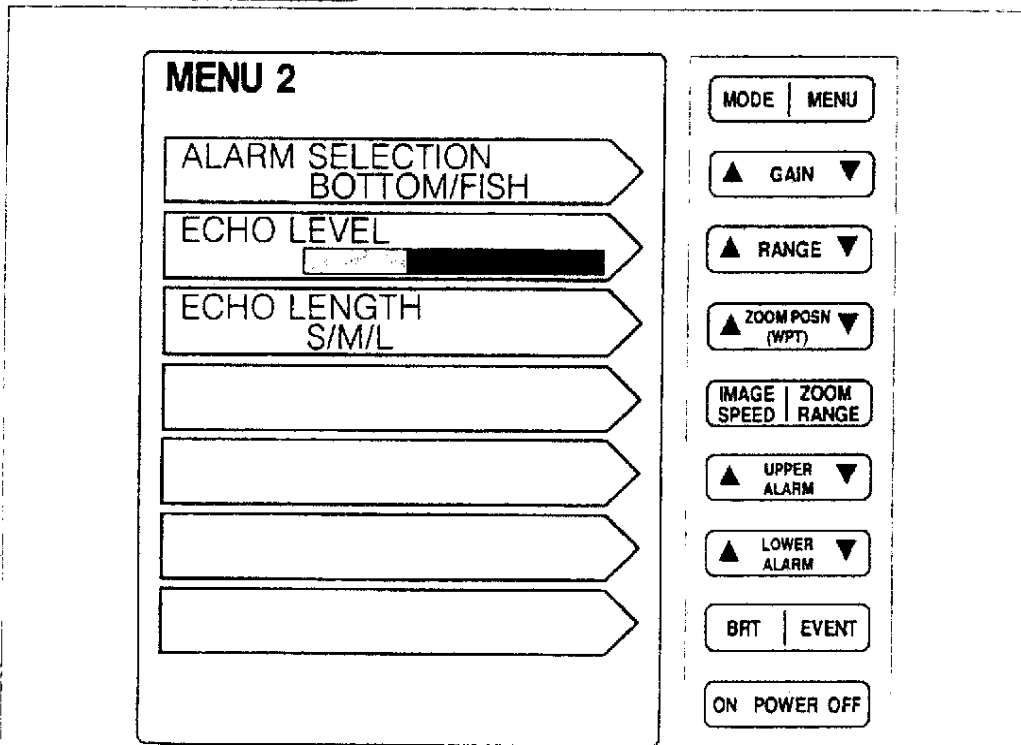

Selecting alarm

ALARM SELECTION
BOTTOM/FISH

▲ GAIN ▼

There are two types of alarms, one is Bottom Alarm and the other Fish Alarm.
In Menu 2, we have two ways of setting the Fish Alarm.

Selecting the echo level of fish

ECHO LEVEL

▲ RANGE ▼

The Fish Alarm can be set to sound on different levels of echo return. For example:
to Sound Alarm on larvae fish only, turn off dark medium amber colors.

Selecting the size of fish



The Fish Alarm can be set to sound on different size of fish.

- S: Fish Alarm sounds when there are small fish
- M: Fish Alarm sounds when there are medium fish
- L: Fish Alarm sounds when there are large fish

Setting fish alarm

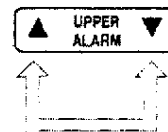
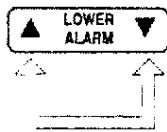
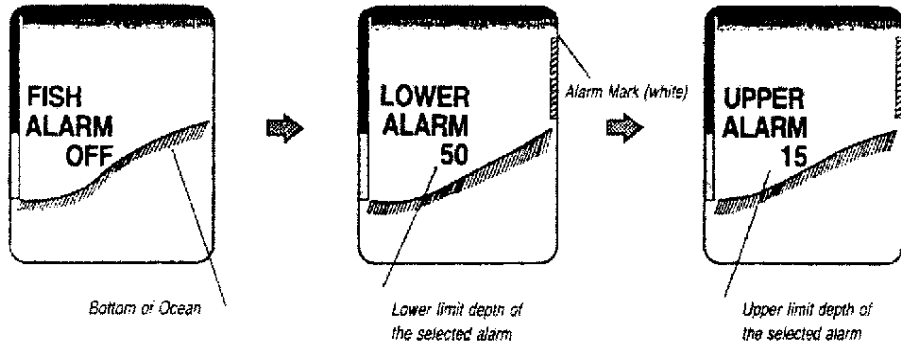

"Fish Alarm Off" appears when push Lower Alarm key ▲ or ▼

After "Fish Alarm Off" appeared, Lower limit depth and white Mark (for alarm range) will be shown if you push ▲ or ▼ again

Taking same method of selecting lower limit depth to set upper limit depth

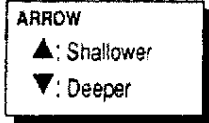

Storing Event Data

The following event data is storable by simply pressing the **EVENT** key:

- Bottom depth
- Water temperature (*Built-in or separate SPEED/TEMP sensor must be connected*)
- Boat position (*Navigator must be connected.*)

The event data stored is recalled in numerals and letters on the screen by simply pressing the **EVENT** key again.

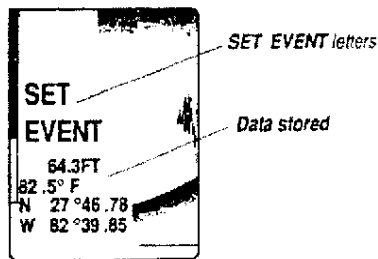

BRT | **EVENT** *Storing*

Press **EVENT** key to display the letters **SET EVENT** on the screen, and the event data is stored in the memory. The stored data is displayed as well in the lower left corner of the screen.



BRT | **EVENT** *Recalling*

Press **EVENT** key again to remove the data from the screen. For recalling the data, press the key again.

For information about resetting the data stored, see *Clearing event data stored* on page 19 of this operation manual.

Displaying BIG NUMBER Mode Screen

The following data is displayed in large lettering by simply pressing the **MODE** key:

- Water temperature (Built-in or separate SPEED/TEMP sensor must be connected.)
- Boat speed (Built-in or separate SPEED/TEMP sensor must be connected.)
- Trip mileage (Built-in or separate SPEED/TEMP sensor must be connected.)
- Boat position (Navigator must be connected.)
- Bottom depth
- Heading and deviation to course (DC-400 fluxgate compass must be connected.)
- Course and deviation to course (DC-400 fluxgate compass must be connected.)

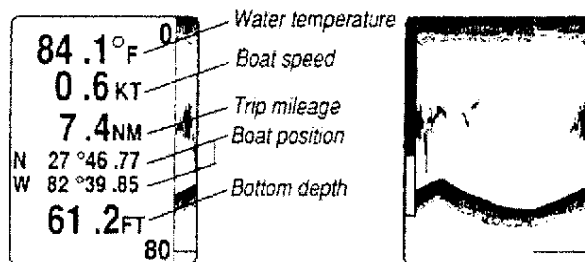

MODE MENU

Press **MODE** key, and the large readouts on water temperature, boat position, trip mileage, boat position, and bottom depth appear on the screen with echo sounder image left at the right end of the screen.

MODE MENU

Press **MODE** key again to display the echo sounder image again. For recalling the big number display, press the key again.

When DC-400 fluxgate compass is interfaced, the boat position is replaced with heading or course data.

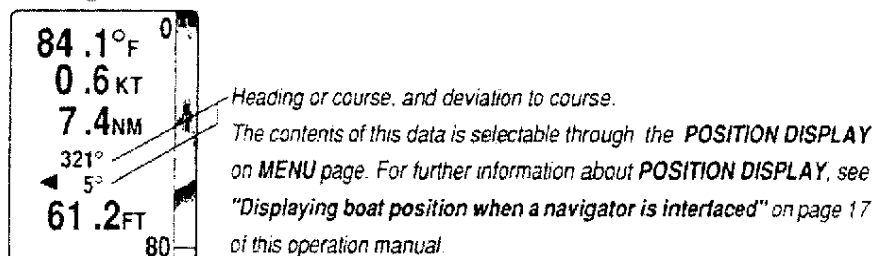

Opening MENU Display

Press **MENU** key and enter new parameters when you want to:

- Eliminate excessive visual noise.
- Eliminate undesired presentation colors.
- Display your boat position.
- Change the unit of boat speed and trip mileage.
- Change the unit of water temperature.
- Reset the trip meter (trip mileage).

MODE | MENU

Press **MENU** key to open the **MENU** page.

Each item of **MENU** screen corresponds to the right hand side key. To change the parameter, press left or right part of each key corresponding to the item. For example, to change the parameter of the item **INTERFERENCE REJ.** from 1 to 2, press right side of **GAIN** key; on the other hand to change from 1 to OFF, press left side of the key. Other parameters can be changed in the same manner. The parameter selected is displayed in yellow.

MENU	MODE MENU
INTERFERENCE REJ. OFF / 1 / 2	▲ GAIN ▼
COLOR REJECTION	▲ RANGE ▼
POSITION DISPLAY OFF / LL / LOP	▲ ZOOM POSH (WPT) ▼
BOAT SPEED DISPLAY OFF / KM / MPH / KT	IMAGE ZOOM SPEED RANGE
TEMP. DISPLAY OFF / °C / °F	▲ UPPER ALARM ▼
TRIP METER RESET NO / YES	▲ LOWER ALARM ▼
EVENT DATA CLEAR NO / YES	BRT EVENT
	ON POWER OFF

Eliminating interference noise

INTERFERENCE REJ.
OFF / 1 / 2

▲ GAIN ▼

The image affected by interference may be displayed when the echo sounder on another boat around you employs the same frequency as yours. In such a case, this undesired visual noise can be eliminated.

- OFF: No elimination is applied.
- 1: Weak elimination is applied.
- 2: Strong elimination is applied.

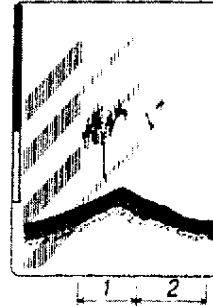

Notes

- If no noise is displayed on the screen, select OFF to display proper image.
- When the screen is filled with noise, select 2 to eliminate excessive noise.

Eliminating undesired colors

COLOR REJECTION

▲ RANGE ▼

Undesired low-signal-level colors can be rejected to eliminate misinterpretation of images on the screen. The colors are erased in the order of dark amber, Medium amber, and light amber. Refer to the color bar scale displayed at the left end of the screen.

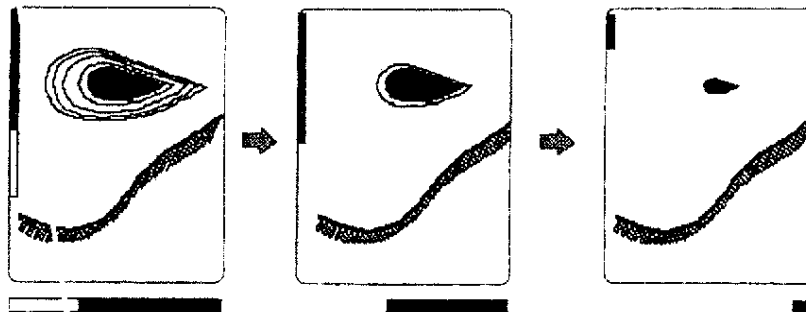

Displaying boat position when a navigator is interfaced

If your boat is equipped with a navigator such as GPS or Loran C, your boat position can be digitally displayed either in latitude/longitude or in Loran C LOP's coordinate. Select your desired coordinate for displaying the position.

POSITION DISPLAY
OFF / LL / LOP

▲ ZOOM POSN (WPT) ▼

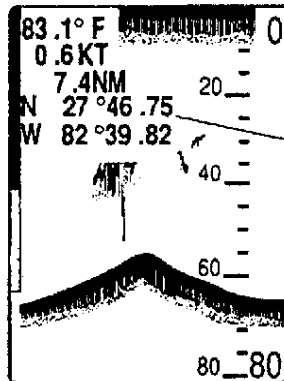

Present position

OFF: When position data is not necessary or no navigator is connected.
LL: Latitude/longitude
LOP: Loran C LOP's

Refer to *Interfacing navigator or DC-400 fluxgate compass* on Page 22 for information about setting input format.

Displaying heading or course data when DC-400 compass is interfaced

Refer to *Opening INITIAL Display* on Page 20.

If your boat is equipped with DC-400 fluxgate compass, your boat heading with deviation to course, or course and deviation to course can be digitally displayed instead of above-mentioned boat position.

Select either HDG (Heading) or STG (Steering) through POSITION DISPLAY menu of MENU page. (For more information about POSITION DISPLAY, see page 15 of this operation manual.)

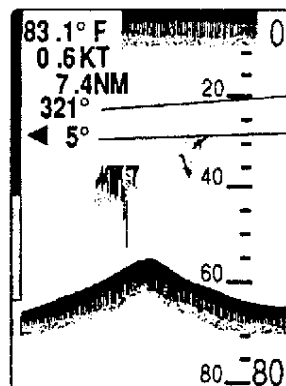

POSITION DISPLAY
OFF / HDG / STG

Heading or steer to go

Deviation to course (arrow indicates the direction of deviation)

HDG: Heading and deviation to course are displayed.
STG: Course and deviation to course are displayed.

Selecting unit of boat speed

If your system employs built-in or separate temp/speed sensor, your boat speed and trip mileage are digitally displayed. Select your desired unit of measuring speed.

BOAT SPEED DISPLAY
OFF/KM/MPH/KT

IMAGE | ZOOM
SPEED | RANGE

OFF: When speed data readouts are not necessary or no temp/speed sensor is connected.

KM: Kilometer per hour

MPH: Mile per hour

KT: Knot

Selecting unit of water temperature

If your system employs built-in or separate temp/speed sensor, surface water temperature is digitally displayed. Select your desired unit of measuring temperature.

TEMP. DISPLAY
OFF / °C / °F

▲ UPPER
ALARM ▼

OFF: When temperature data readouts are not necessary or no temp/speed sensor is connected.

°C: Celsius

°F: Fahrenheit

Resetting trip mileage

The trip mileage digitally displayed on the screen is reset by selecting **YES** of this parameter. Press ▼ arrow of **LOWER ALARM** key, and the letters **YES** will be displayed in yellow and trip mileage will be reset. Once it is reset, the trip mileage starts counting from zero again. The letters **NO** is highlighted when the trip meter (mileage) is reset.

TRIP METER RESET
NO / YES

▲ LOWER
ALARM ▼

Clearing event data

The event data (bottom depth, water temperature, and boat position) is cleared by selecting **YES** of this parameter. Press **EVENT** key, and the letters **YES** will be displayed in yellow and event data stored will be cleared. Once it is cleared, a new event data can be stored in the echo sounder screen. The letters **NO** is highlighted when the event data is reset.

EVENT DATA CLEAR
NO / YES

BRT | EVENT

Returning to echo sounder screen



MODE | MENU



Press **MODE** key, and echo sounding screen will appear.

Opening INITIAL Display

Use initial menu to enter new parameters when:

- Your boat speed and trip mileage differs from the actual ones.
- You want to use other unit of measure.
- You want to interface with navigator for displaying boat's position or DC-400 fluxgate compass for displaying navigational data such as heading and deviation to course, or course and deviation to course.

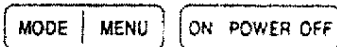

While holding down MENU key press POWER ON key.

Each item of INITIAL screen corresponds to the right hand key. To change the parameter, press left or right part of each key corresponding to the item. For example, to change the parameter of the item SPEED CORRECTION from -50 to -30, press right side of GAIN key: on the other hand to change from -30 to -50, press left side of the key. Other parameters can be changed in the same manner.

The selected parameters are highlighted.

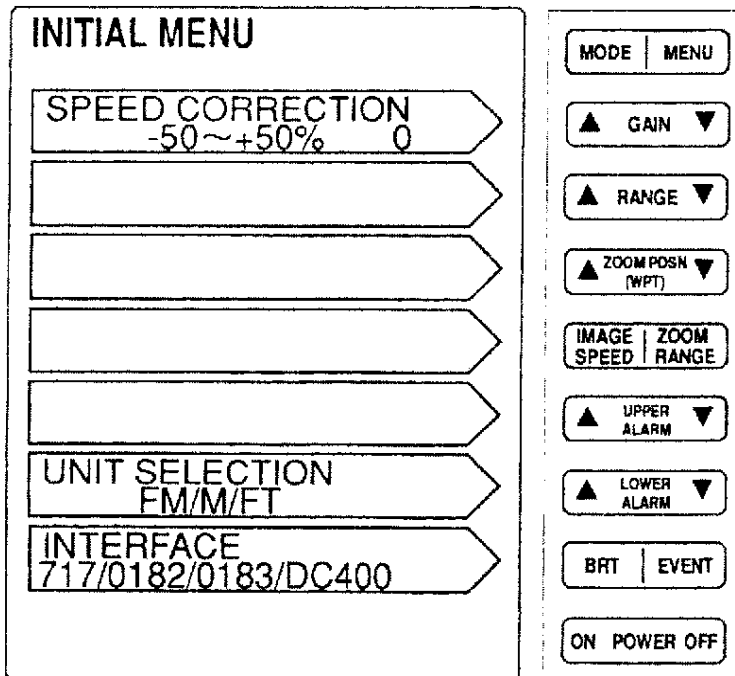

Correcting boat speed and trip mileage

SPEED CORRECTION
-50~+50% 0

▲ GAIN ▼

If your system employs built-in or separate temp/speed sensor, your boat speed and trip mileage are digitally displayed. However, when trip mileage differs from the actual distance on the sea chart, your boat speed can be compensated in the correction range of -50% through +50% at an interval of 5%. Measure the distance between two points on the sea chart and compare it with the actual traveled distance. The correction value in percentage can be given by the equation in the note below. For example, the distance on the sea chart indicates 55 NM and the actual travelling distance is 50 NM, select +10%.

Note

$$\text{Correction value (\%)} = \frac{\text{Distance on the sea chart} - \text{Actual travelling distance}}{\text{Actual travelling distance}} \times 100$$

Selecting unit of measure

UNIT SELECTION
FM/M/FT

▲ LOWER ALARM ▼

The unit of measure for depth is selectable from:

- FM (Fathoms)
- M (Meters)
- FT (Feet)

Select the appropriate unit of measure for your particular application.

Interfacing with navigator or DC400 fluxgate compass

The following data format setting is necessary for interfacing with a navigator or fluxgate compass DC-400. If you interface with navigator your boat position is displayed; on the other hand, if you do with DC-400 fluxgate compass, heading and deviation to course or course and deviation to course is displayed.

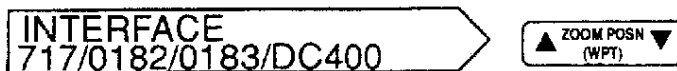

The signal format for interface is selectable from:

- 717 (KODEN-717) LLL/OP
 - 0182 (NMEA-0182) LL
 - 0183 (NMEA-0183) LL/OP
 - DC400 (DC400 fluxgate compass)
- For displaying boat position from external position fixing equipments like Ioran or GPS receivers.
- For displaying heading and deviation to course, or course and deviation to course

Select the appropriate input data for your particular application.

INSTALLATION

Transducer Installation and Maintenance

CAUTION

Mounting your transducer whether transom mounted or thru-hull, requires drilling holes into or through your hull or transom which can affect its water integrity and, therefore, should be attempted only by competent persons. If you are in doubt as to your competence to attempt this installation, we recommend taking your boat to a marine dealer and/or marina that has people qualified and experienced in transducer installations.

Speed Sensor - Installation and Maintenance

If your system is equipped with a speed sensor assembly, detach the speed sensor before proceeding to install the depth housing. Once the depth housing has been secured in place, reattach the speed sensor and make sure shear pins and tabs are engaged.

If the speed impeller (paddle wheel) becomes fouled, remove the 4 screws that secure it to the transducer housing. Clear the obstruction and inspect the shaft and bearings for excessive wear. Replace if worn. Reinstall parts and attach to housing. Spin paddle wheel making sure that it spins freely (transomount type)..

If the impeller assembly is kept in salt water, the speed assembly should be protected with anti-fouling paint. To allow proper fitting of the snap together assembly, do not paint mating surfaces. All other exposed surfaces can be coated.

The speed sensor shear pins are designed to fracture upon impact. Be sure to remove speed sensor before beaching or when boat is hauled by fork lift. Hauling and beaching are the main cause of impeller carrier breakage.

Cleaning transducer

The housing material is polycarbonate which has high strength and impact resistance. Do not use strong solvents of any type to clean the transducer. Strong solvents, such as acetone, can quickly weaken and fracture the plastic housing. Do not use thread seizing compound since some contain ketone solvents. Exposure to gasoline also degrades the housing.

Saltwater maintenance

Antifouling paint-If the vessel is kept in saltwater, sea growth on the transducer face can accumulate rapidly and seriously reduce performance in a matter of weeks. It is recommended that at least the acoustic face of the transducer be coated with an anti-fouling paint. Alternatively, the entire transducer can be painted and then generally is easier to keep clean. Most copper base paints are satisfactory although transducer paints are available. If fouling does occur, use a stiff brush or putty knife to remove growth. Wet sanding of fouled surfaces is permissible with #220 or finer grade wet or dry paper.

Transom Mount Transducer Mounting Procedure

Since your video sounder's performance depends on how well the transducer or Triducer has been installed, please carefully read through the following mounting procedures:

1. For proper performance, the transducer mounting location must be chosen carefully. The transducer should be mounted in a location that is free of white water: that is, free of turbulence and air bubbles created by movement of the boat as it travels through water. Air bubbles greatly reduce the efficiency of the transducer. To determine the best mounting location, operate the boat at several different speeds and observe the water as it passes under the transom. Study the turbulence created by the hull structure, the keel, and the lifting strokes. Keep the transducer and its cable as far as possible from the boat's power cables, tachometer, and other electrical cables.
2. This type of transducer has been designed to give you excellent readings by being installed on the transom of almost all boat types, however, the transom transducer should not be mounted on boats with in-board engines or trim tabs. In these instances, the thru-hull transducer should be used.

CAUTION You should not use any other make of transducers with your video sounder. The performance of your echo sounder might be degraded if you use a transducer other than those SI-TEX recommends.

3. Dimensions. see Figures 1 and 2.
4. Example of a transom mount transducer

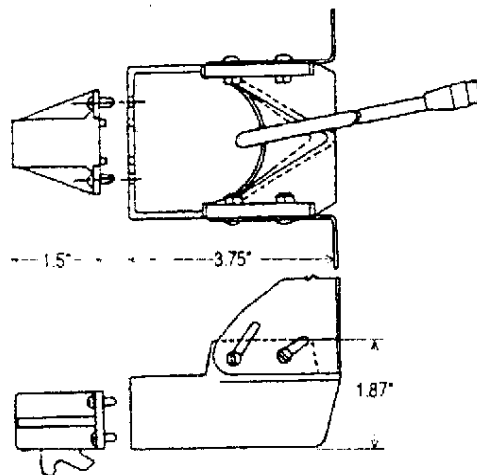

Figure 1

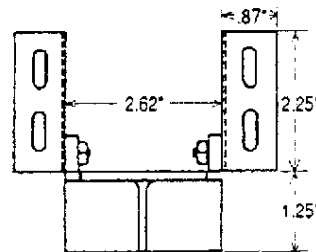
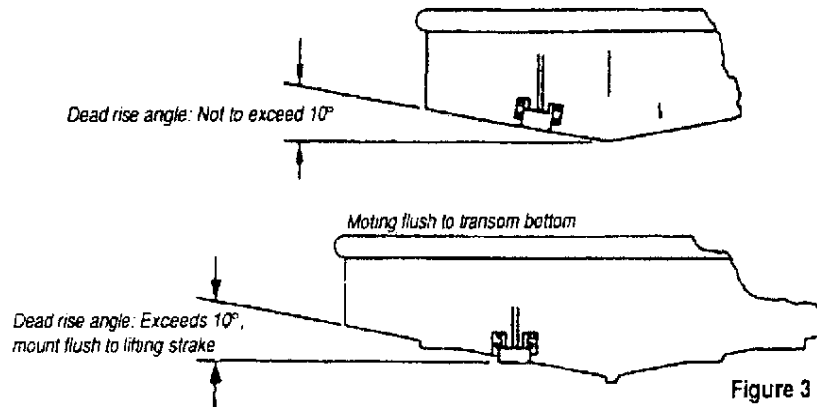
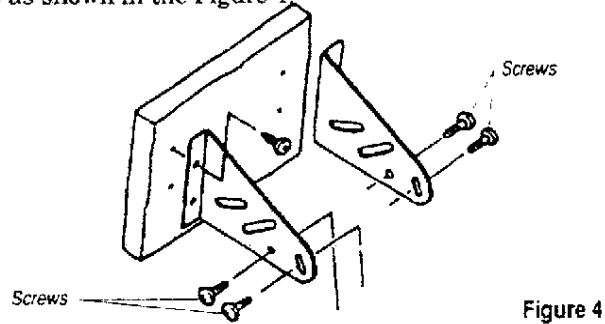

Figure 2

- Determine the transducer mounting place by referring to Procedures 1 and 2 on page 24. As the transducer can disturb water flow to the boats propeller, we recommend port side indicated as follows:



- Tentatively fix two bracket plates to the transducer using 4 sets of screws, nuts, and washers as shown in the Figure 4.



- Place the transducer along the transom and determine the exact bracket mounting position by referring to Figure 5.

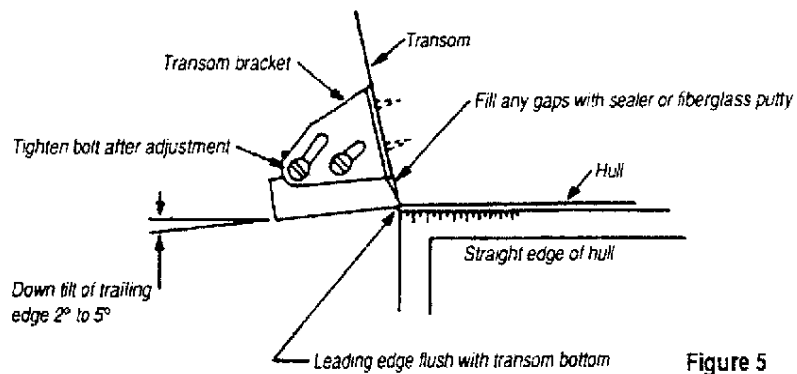

Improper Transom Mount Transducer Installation

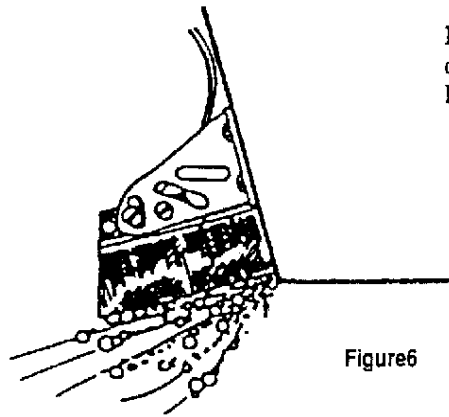

Bow of transducer is above transom creating cavitation.
Bow of transducer should be lowered.

Figure 6

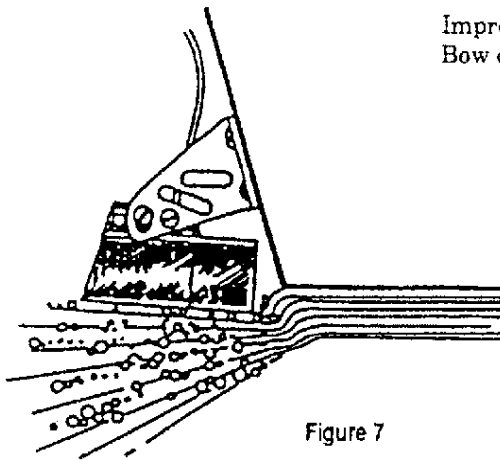

Improper angle cavitates transducer face.
Bow of transducer should be raised.

Figure 7

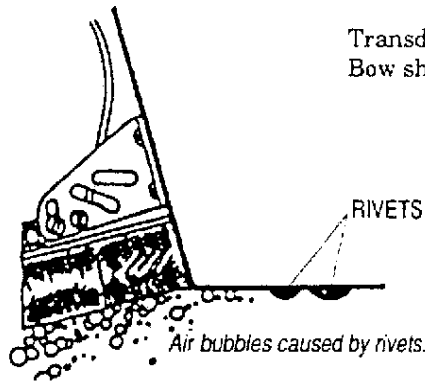

Transducer should be lowered.
Bow should be raised also.

Figure 8

Thru-hull Transducer Mounting Procedure

Outlines and dimensions

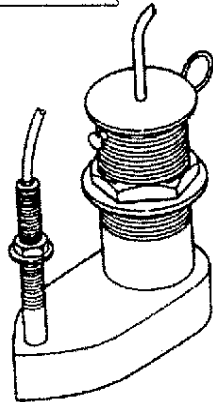

Figure 9

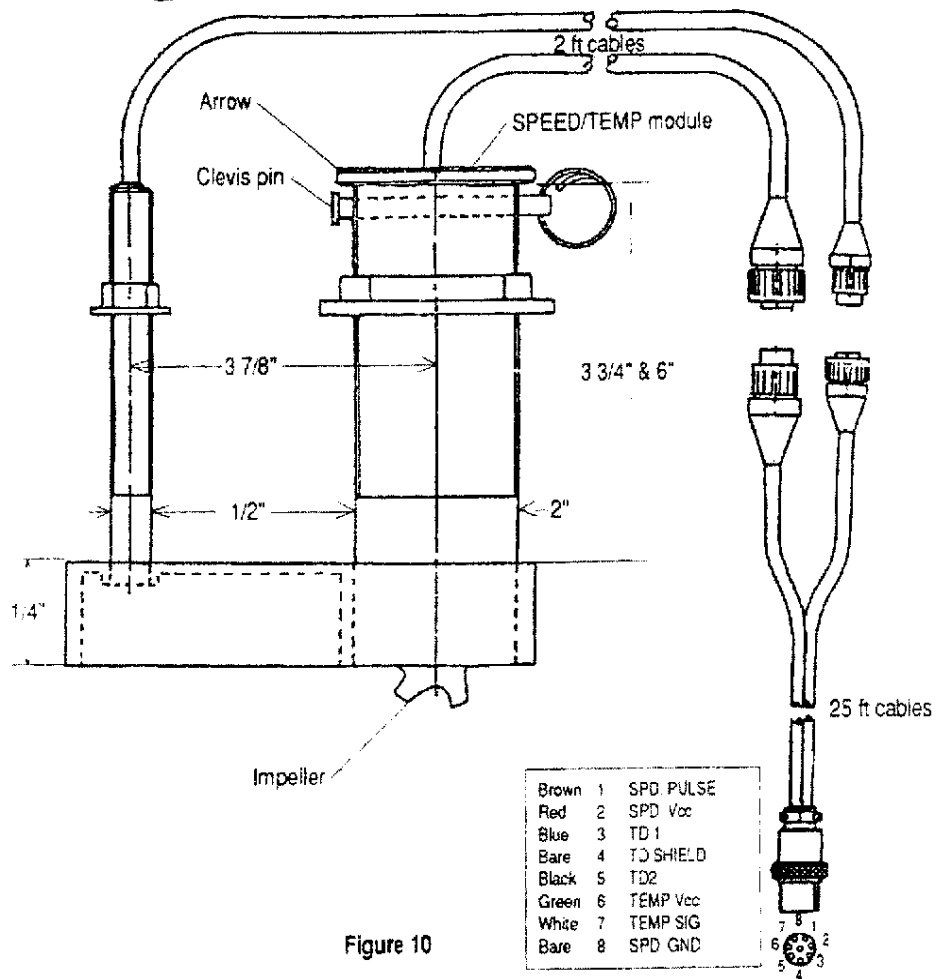

Figure 10

Installation

To prevent the transducer surface from being affected by bubbles or water spiral, install the thru-hull Transducer after reading the following:

- (A) The transducer should be installed at a place where no bubbles and no water spiral are generated around it.
- (B) The transducer should be installed as far from the engine as possible, but not too close to the bow. Normally, the transducer should be installed in the middle of 1/3 of the hull, at speed as shown in Figure 11.
- (C) In case of flat bottom hull, the transducer can be installed in the constant water flow and parallel with the water surface - this is an ideal installation because the transducer surface, being in the constant water flow, generates few bubbles or water spirals and the transducer surface can emit the ultrasonic wave perpendicularly in the water for receiving better echoes from the targets beneath your boat.

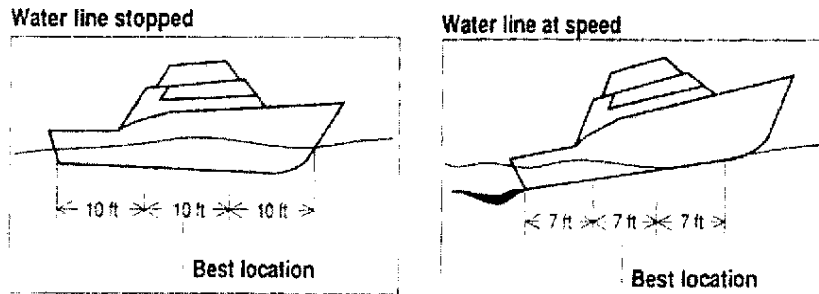
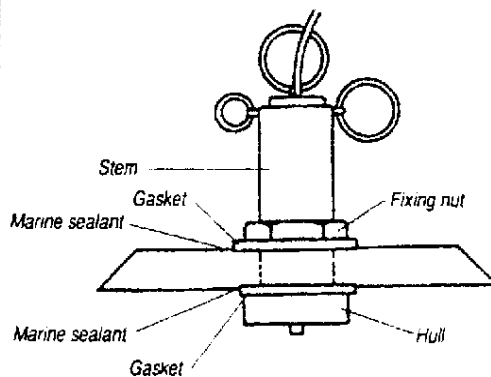

Figure 11

In case of the bottom hull with a deadrise

- (A) In case of deadrise of less than 5 degrees, you can install the transducer stem perpendicularly to the bottom hull as shown in Figure 12.
- (B) In case of deadrise of 5 degrees or more, you should mount an inner fairing block between inside hull and fixing nut, and an outer fairing block between outside hull and transducer so as to maintain the transducer surface in parallel with the water surface as shown in Figure 13.
- (C) Fairing blocks are available from SI-TEX.



Without fairing block

Figure 12

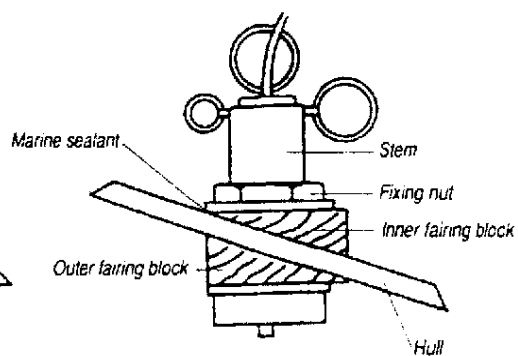

With fairing block

Figure 13

Installing procedure

Without fairing block:

- (A) Referring to previously mentioned items, select an appropriate installation place on your boat.
- (B) Remove the fixing nut from the stem and cable.
- (C) Make holes at the selected installation location. (Verify stem diameter prior to drilling hole.)
- (D) Pass the transducer cable and transducer stem from outside to inside of hull through the hole. To prevent water leakage through a gap between the hole and thread on the stem, apply FRP or marine sealant onto the stem.
- (E) Carefully attach and secure the fixing nut to the stem.
DO NOT OVER TIGHTEN.

With fairing block:

- (A) Referring to previously mentioned items, select an appropriate installation place on your boat.
- (B) Remove the fixing nut from the stem and cable.
- (C) You can fabricate a fairing block out of hard wood or FRP.
- (D) Cut the fairing block to the hull deadrise angle. (If you are fabricating your own block, you first have to drill 2" hole in the block.)

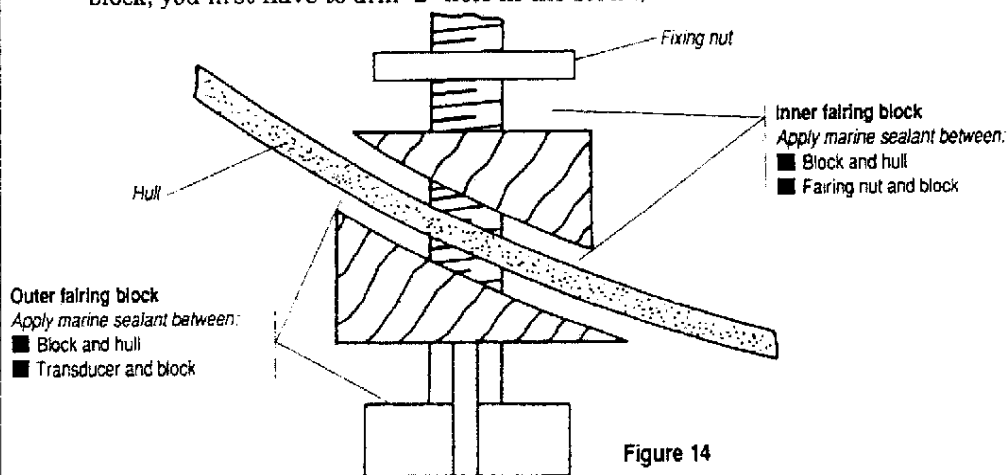

- (E) Place the lower portion of the fairing block against the bottom of the hull at the selected mounting location.
Mark the hull or stem location through the hole in the block.
- (F) Cut the hole to the transducer stem size.
- (G) Apply marine sealant to both sides of the lower portion of the fairing block, transducer stem and bottom side of the upper portion of the fairing block.
- (H) Pass the cable and stem up through the lower portion of the fairing block, the hole in the hull and upper portion of the fairing block.
- (I) Loosely tighten the fixing nut to the stem.
- (J) Carefully align lower fairing block, the Transducer and upper fairing block. Tighten the fixing nut to the stem.
DO NOT OVERTIGHTEN especially if wooden block used.

Regarding the water plug

When you need to check the inner sensor, insert the water plug into the housing as soon as you remove the inner sensor so as to prevent water leakage from the hole. It is recommended that you keep the water plug beside the sensors.

Note

Different manufacturers, dimensions features and physical design, differences may be noted from these instructions. Contact your dealer or SI-TEX Marine Electronics to answer your question.

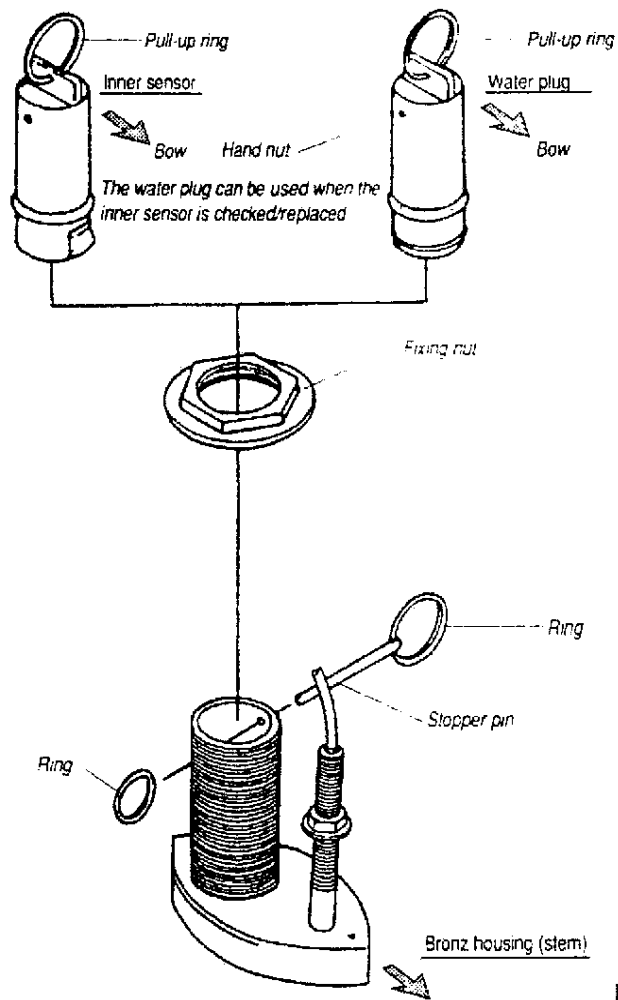

Figure 15

Mounting Video Sounder

Dimensions and weight

Unit: mm (inch)

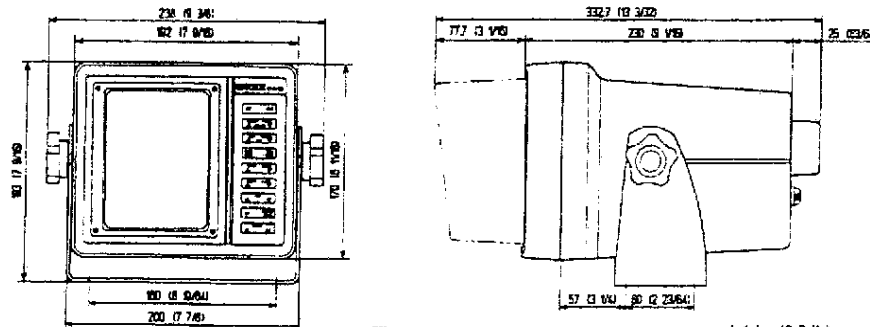

Figure. 16

4.1 kg (9.0 lb)

Installing the mounting bracket

The video sounder should be installed on a flat, solid surface for maximum stability. You can mount the bracket on a swivel mount which has the same mounting holes as your bracket. You can also mount your bracket overhead. Position the bracket, mark and drill four 1/4" holes. Secure it using four self-threading screws provided. Make sure that the bracket slot face forward.

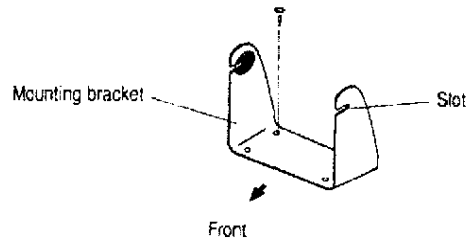
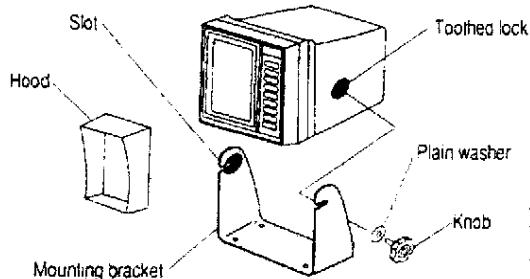

Figure. 17

Mounting the video sounder

Place the video sounder in the bracket and secure it to the bracket using two bracket knobs as shown in Figure. 18.



For overhead mounting, carefully holding your video sounder, secure it to the bracket.

Figure. 18

Connecting Cable Plug

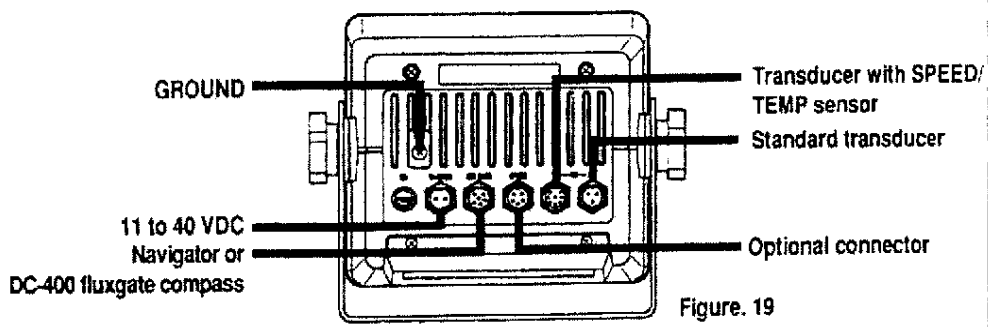

Figure. 19

Plug pin arrangement

Five connectors are mounted on the rear panel including the power connector. The functions and pin arrangements are specified below.

11~40VDC



Power input (11 to 40 VDC)

- ① LINE + : Red wire
- ② LINE - : Black wire

Use the attached power cable with a fuse. Be careful with + and - polarities. If a thin wire is used as an extension cable, it may cause the performance of this unit to deteriorate and also produce other problems. Use a cable of Stranded wire 16 AWG or larger.

SER DATA

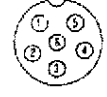

Serial data (Navigator and DC-400)

- ① SHLD (Shield)
- ② SIG (TX)
- ③ RTN (TX)
- ④ SIG (RX)
- ⑤ RTN (RX)
- ⑥ NC (No connection)

OPTION



Option

This connector is provided for system extension in the future. It is not currently used.

TRI



STD

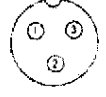

Transducer with SPEED/TEMP sensor or standard transducer

- | | | |
|--------------|------------|-------------|
| ① SPD. PULSE | ⑤ TD 2 | STD |
| ② SPD. Vcc | ⑥ TEMP Vcc | ① TD 1 |
| ③ TD 1 | ⑦ TEMP SIG | ② TD SHIELD |
| ④ TD SHIELD | ⑧ SPD. GND | ③ TD 2 |

Be careful with the insulation of transducer pins ③ and ⑤ in transducer with SPEED/TEMP sensor or standard transducer pins ① and ③ from other pins as high voltage is applied to these pins.

Troubleshooting

1. Make sure that your video sounder, or transducer, and power cable are correctly installed as instructed.
2. Press **POWER ON** key, adjust **GAIN** until the bottom image is displayed in red, adjust screen brightness for comfortable brightness. Your video sounder will automatically give you the factory-settings.
3. If nothing happens after turning on, check power cable connection, power cable, fuse, and power source.
4. If you cannot see your desired image on the screen with the initial setting, first set the **RANGE** deeper and readjust the **GAIN**.
5. If the data indicating functions relative to the **SPEED/TEMP** sensor, such as boat speed, and water temperature indications, looks incorrect, check **SPEED/TEMP** sensors of the transducer as well as connection between the unit and transducer.
6. If you have different problems from the items described above, we suggest that you contact your dealer indicating the trouble symptom status.
7. Notwithstanding all of the great features of a color video sounder, one weakness is they are hard to see in some bright daylight situations on an open boat. Your **CVS-106** comes with a plastic hood to help combat this problem.

SPECIFICATIONS

Major Specifications

Display	6-inch monochrome display
Resolution	256 x 256 pixels
Presentation	3 shades of amber
Frequency	50, 120, or 200 kHz
Output	200 watts R.M.S. (1600 watts Peak to peak)
Presentation mode	NORM, ZOOM, AUTO RANGE, AUTO ZOOM, BIG NUMBER
Depth range	5, 10, 20, 40, 80, 160, 320 (meters or fathoms) 10, 20, 40, 80, 160, 320, 640, 1280 (feet)
Zoom range	1/2 and 1/4 of the selected depth range
Zoom position	Settable within the displayed depth range (at an interval of 12.5% of the displayed range)
Image speed	5 fixed speeds plus STOP
Alarms	Upper and lower bottom alarms — fish alarm
Other functions	Gain, screen brightness, color rejection, noise rejection, STC, interference rejection, measuring unit, water temperature display (*1), boat speed display (*1), boat position display (*2), instant memory (water temperature, boat position, depth), boat speed compensation (*1) heading (*3), course (*3), deviation from course (*3)
Input data	NMEA-0183, NMEA-0182, KODEN-717, DC-400
Output data	NMEA-0183 (water temperature, boat speed, depth)
Power supply	11 to 40 VDC
Power consumption	25 W
<p>Notes:</p> <p>(*1) : Built-in or separate SPEED/TEMP sensor is required. (*2) : Navigator is required. (*3) : DC-400 fluxgate compass is required.</p> <p>* Specifications subject to change without notice.</p>	

Equipment List

Article name	Remarks	Quantity
Display unit	with bracket and vinyl cover	1 (4.1 kg, 9.0 lb)
Hood	plastic	1
Transducer	with cable and connector	1
DC power cable	with connector	1 (2m, 4.4ft)
Spare fuse	F7142, 5A	3
Installation materials	* tapping screws (TPTM6 x 25U)	1 set
Operation manual		1

APPENDIX

NMEA-0183 Output Format

Data configuration

The bit configuration of one byte is as specified below.

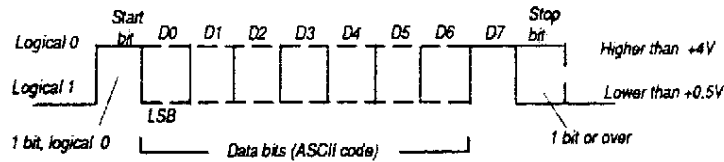

Data specifications

Output sentence: SDDBS + SDMTW + SDVHW (Total: 73 characters, 18 msec)

Baud rate	Output level	Output current	Transmitting cycle
4800 bauds	TTL level	Max. 5mA	4.6 seconds.

Sentence descriptions

Descriptions	Contents of data fields
SDDBS	<p>Depth of water below surface</p> <p>\$ SD DBS, XXXX.X, f, XXXX.X, M, XXX.X, F C/R L/F</p> <p>Start of sentence Device (Depth sounder) Contents (Depth) Depth Unit of measure (Feet) Depth Unit of measure (Meter) Depth Unit of measure (Fathom) Sentence terminator</p>
SDMTW	<p>Meteorological temperature water</p> <p>\$ SDMTW, XX, C C/R L/F</p> <p>Contents (Temperature) Temperature Unit of measure (C: Celsius)</p>
SDVHW	<p>Vectors, Heading, and water speed</p> <p>\$ SD VHW, XX.X, N, XX.X, K C/R L/F</p> <p>Contents (Vectors, heading, and water speed) Speed Unit of measure (Knot) Speed Unit of measure (Kilometer)</p>

CERTIFICATE OF LIMITED WARRANTY

Providing you present a valid proof of purchase, SI-TEX Marine Electronics Inc. warrants all parts of each new product against defect in material and workmanship under normal use and will repair or exchange any parts proven to be defective at no charge for a period of two years for parts and one year for labor from the date of purchase, except as provided below under Limited Warranty Exceptions.

Defects will be corrected during normal working hours by an authorized SI-TEX Marine Electronics Inc. dealer, service center, or at the SI-TEX office in St. Petersburg, Florida. There will be no charge for labor for a period of one year from the date of purchase, except as provided below under Limited Warranty Exceptions.

This Warranty and Proof of Purchase must be made available to the authorized SI-TEX Marine Electronics Inc. service location or dealer at the time of service.

LIMITED WARRANTY EXCEPTIONS

SI-TEX Marine Electronics Inc. will not be responsible for equipment which has been subjected to water or lightning damage, accident, abuse, or misuse nor any equipment on which the serial number label has been removed, altered or mutilated.

SI-TEX Marine Electronics Inc. assumes no responsibility for damage incurred during installation.

This Limited Warranty is effective only with respect to the original purchaser.

Any cost associated with transducer replacement, other than the cost of the transducer itself, is specifically excluded from this Limited Warranty.

Travel cost incurred will not be accepted for SI-TEX Marine Electronics Inc. products.

THERE ARE NO WARRANTIES WHICH EXTEND BEYOND THE DESCRIPTION OF THE FACE HEREOF.

SPECIFIC EXCLUSIONS

Charges for overtime, stand-by, holiday, and per diem are specifically excluded from the Limited Warranty.

Chart paper, stylus, stylus belt, lamps, and fuses are consumable items and are not covered by this Limited Warranty.

Installation workmanship or materials except as provided directly by SI-TEX Marine Electronics Inc. are not covered by this Limited Warranty.

SI-TEX Marine Electronics Inc. equipment or parts thereof which have been repaired or altered except by an authorized SI-TEX Marine Electronics Inc. dealer or service center are not warranted in any respect.

Transducer, software update, battery, microphone, magnetron, and microwave components and water damage on water resistant VHF radio are items excluded from the two-year warranty and are covered by warranty for a period of one year for both parts and labor.

SI-TEX Marine Electronics Inc. will not, at any time, assume any costs or labor charges for checkout or external line fuse replacement or problems not found to be at fault in equipment itself.

THERE ARE NO WARRANTIES OR GUARANTEES EXPRESSED OR IMPLIED WHICH EXTEND BEYOND THE DESCRIPTION ON THE FACE HEREOF, INCLUDING WARRANTIES OF FITNESS FOR A PARTICULAR PURPOSE AND MERCHANTABILITY. SI-TEX MARINE ELECTRONICS INC. HAS NO OTHER LIABILITY TO PURCHASE FOR DIRECT OR CONSEQUENTIAL DAMAGE OR ANY THEORY INCLUDING ABSOLUTE LIABILITY, TORT, OR CONTRACT. THIS LIMITED WARRANTY CANNOT BE ALTERED OR MODIFIED IN ANY WAY AND SHALL BE INTERPRETED IN ACCORDANCE WITH THE LAWS OF THE STATE OF FLORIDA. THIS WARRANTY IS LIMITED TO THE CONTINENTAL U.S.A., ALASKA, HAWAII, AND CANADA.

HOW TO OBTAIN SERVICE UNDER THIS WARRANTY

To provide better flexibility, SI-TEX Marine Electronics Inc. gives you the option of obtaining service under this warranty by either:

a) Contacting an authorized SI-TEX Marine Electronics Inc. service station (The closest service station may be found by contacting your dealer of purchase.)

or

b) Shipping your equipment prepaid via UPS or truck with insurance prepaid to SI-TEX Marine Electronics Inc. at the address provided below.

SI-TEX Marine Electronics Inc. will, whenever possible, make all repairs covered by Limited Warranty within two weeks of receiving the equipment in Florida and return same to you, freight prepaid.

c) You must present a copy of your Purchase Sales Slip at the time you request warranty service.

Shipping/Mailing Address:

SI-TEX Marine Electronics Inc.
11001 Roosevelt Blvd., Suite 800
St. Petersburg, FL 33716
727-576-5734

SI-TEX Marine Electronics Inc. offers a complete line of quality marine electronics including fishfinders, electronic charting systems, radars, autopilots, GPS/WAAS/Loran receivers, SSB receivers, direction finders, VHF radios, VHF marine & TV antennas, and integrated systems. For more information, contact your SI-TEX dealer or the main office, located in St. Petersburg, Florida.

NOTES PAGE

NOTES PAGE

NOTES PAGE

SI-TEX MARINE ELECTRONICS INC.

**11001 ROOSEVELT BLVD. SUITE 800
ST. PETERSBURG, FL 33716**

PHONE: 727-576-5734

FAX: 727-576-5547