

# SITEX *PRO FISH III* FISH FINDER

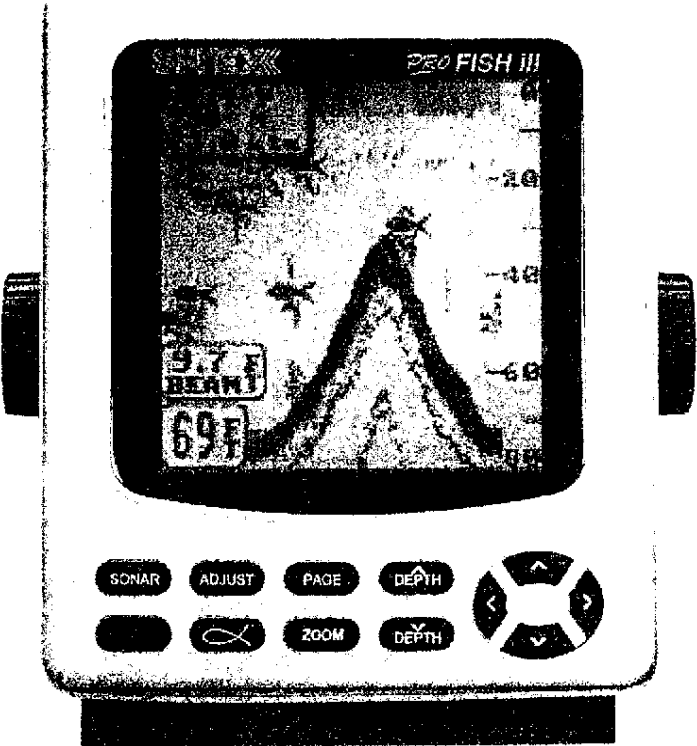

## OWNER'S HANDBOOK

## THE *PROFISH* III SONAR FISHFINDER

### Welcome

Welcome to the SI-TEX *PROFISH* III. You have selected the most advanced and easiest to use fishfinder ever offered to mariners. Whether you are a novice or a professional, your *PROFISH* III gives you the tools to find the fish and when supported by a GPS, it will guide you back to them. Your *PROFISH* III is one more example of SI-TEX's continuing commitment to producing accurate and user friendly products for both commercial and pleasure boating.

#### WARNING

This product is designed to serve as a fish finder. It is not intended to serve as, and should not be relied upon as a sole or primary source of depth information. Because of the possibility of error in reporting depth information, inherent in the use of fish finders, the product should only be used in conjunction with, or by someone trained in the proper use of a fish finder. Your use of this product constitutes your agreement to abide by the instructions, cautions, and warnings contained herein.

#### CAUTION

The *PROFISH* III LCD Fishfinder employs the latest in proven technology to provide accurate navigation information back to the fish location. The STRIKE functions of the *PROFISH* III are totally dependent upon the capability of the GPS navigation source to provide accurate position information. This device is only an aid to navigation. It should be used in conjunction with all other navigation sources such as charts, manual soundings and visual sightings to cross check navigation accuracy. For safety, always resolve any uncertainty before continuing navigation.

#### POWER WARNING

During installation, be sure to use a fused power block with a 2-Amp fuse. If not available, install a 2-Amp in-line fuse holder (not supplied).

#### CAUTION

High power fish finder transmitters may cause, in some situations, uncorrectable VHF radio interference. When using your VHF radio in an emergency, turn the *PROFISH* III Fishfinder OFF.

## Table of Contents

THE <b>PROFISH III</b> SONAR FISHFINDER	1
Welcome	1
Table of Contents	2
Introduction	3
Standard and Optional Equipment	3
GETTING STARTED	4
Using the Built-in Simulator	5
Cursor and Function Keys	6
ZOOM and STRIKE	6
INSTALLATION	9
Transducer Installation	9
Transom Transducer Maintenance	10
Optional Through-hull Transducers	11
Through-hull Transducer Maintenance	12
Display Unit Installation	13
COM DATA	13
TRANSDUCER	13
Mounting the Trunnion Bracket	14
Cable Installation and Routing	14
Rear Panel Connectors	14
Power Connection	15
Transducer Connection	15
Data Connection	15
OPERATION	16
Action and Adjustment Keys	16
Cursor Keys	17
SONAR	17
ZOOM	19
ADJUST Sonar Menu	20
STRIKE	21
MENU Page Screens	23
NAV DATA (Page #1)	23
Menu Page #2 (Control)	24
Menu Page #3 (Control)	25
Menu Page #4 (GPS)	26
SI-TEX <b>PROFISH III</b> COLOR FISHFINDER SPECIFICATIONS	28
REFERENCE	30
Care and Cleaning	30
NMEA	30
Troubleshooting	31
CERTIFICATE OF LIMITED WARRANTY	32

## Introduction

The latest developments in color LCD display technology, microprocessor control and sonar technology have been combined to give you a powerful fish hunting instrument. Your *PROFISH III* Fishfinder has a full color sunlight readable display, 200 Watt rms (1600 W p-p) Sonar transmitter for reading depths up to 600 feet\* and simple push button operating controls. The digital depth is displayed so you will know where the bottom is. The unit uses information from any NMEA 0183 compatible GPS to provide steering and positional pictorial view relative to the fishing spot you have selected. The unit is enclosed in a rugged water resistant, UV stable molded plastic case with provisions for console or overhead mounting. Optional transducer styles with temperature and speed sensors are available to suit your needs.

To get the most from your *PROFISH III*, it is important to take the time to read through this manual and understand its operating features.



## Standard Equipment

- *PROFISH III* Display Unit
- Power Cable - 2 meters long with quick disconnect pins
- Manual (see SI-TEX warranty card at the end of this manual)
- Standard Trunion and Knobs
- DATA Connector Cover Rubber Cap
- Transom Mount Transducer, Depth only, Single Beam, 8 pin connector, 8-meter cable

## Optional Equipment (Contact SI-TEX or Your Dealer)

- Data Cable - 6 pin connector, 1 meter long
- 200 KHz Transom Mount Triducer with Temp and Speed, Single Beam
- Bronze Through-hull Transducer selections:
  - 200 KHz, Depth only, Single Beam
  - 200 KHz, Depth, Temp, Single Beam
  - 200 KHz, Depth, Temp, Speed, Single Beam (Double Stem)

\*Actual depth capabilities may vary due to salinity, bottom hardness and other factors.

## GETTING STARTED

This Getting Started Section will get you acquainted with the basic functions and displays of your new *PROFISH III*. Your *PROFISH III* has a built in simulator which allows the unit to be operated without having your boat in the water or having the transducer connected. It is necessary, however, to have the unit's power cable properly connected to a 12 VDC power source. Refer to Power Connection in the Installation Section.

Please review the following illustration for the locations and uses of function keys. The keys below the display select *PROFISH III*'s basic functions. The keys in a circular arrangement at right are the cursor keys.

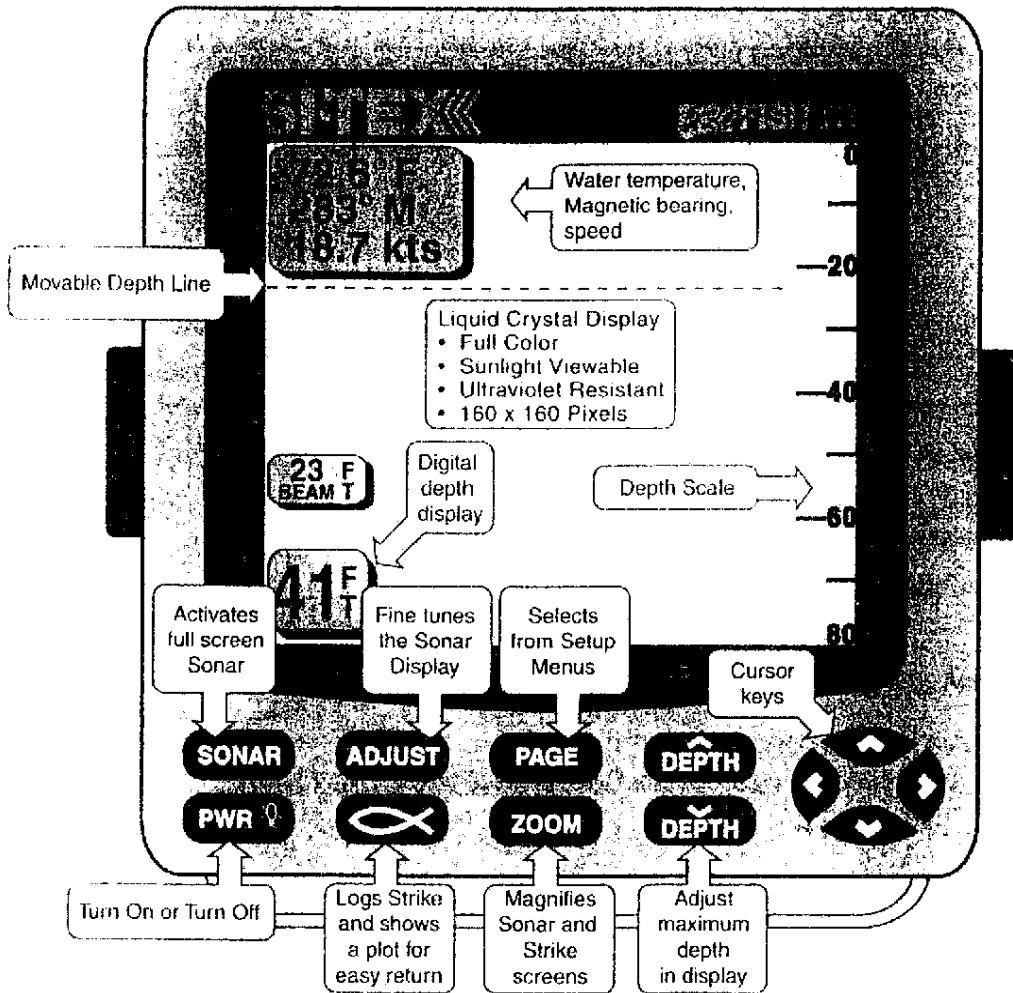

*PROFISH III FRONT PANEL FEATURES*

**POWER ON.** Press the **PWR** key.

After a brief Self Test, the main Sonar screen appears. Any time the *PROFISH III* is switched ON, the Sonar screen is the wake up screen.

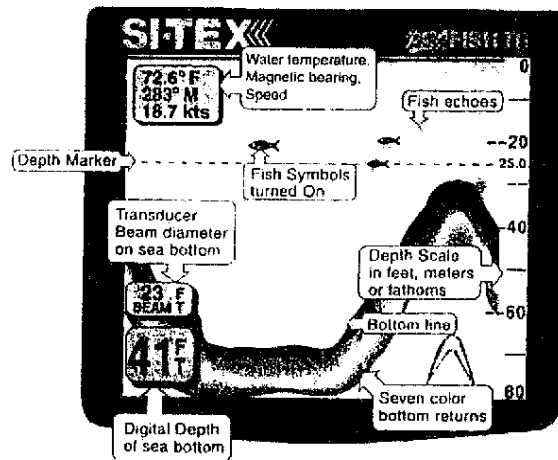

PROFISH III SONAR SCREEN

If you do not want to continue at this time, you may turn your PROFISH III off. If you are ready to move on, note the Power Off sequence for future use and go to Simulator.

**POWER OFF.** Press and hold the **PWR** key for about 3 seconds. The POWER OFF countdown timer display appears, and a fish symbol swims across the screen from right to left. The timer starts at 3 seconds. When the timer is done counting down and the fish reaches the middle of the screen, the unit turns OFF. If you let up the key before the end of the countdown, the sequence is aborted.

Using the Built-in Simulator



The built in simulator allows you to become familiar with all operational features of your PROFISH III without having your boat under way or having to connect a navigation receiver. The Simulator is preprogrammed with sea bottom and fish echoes for Sonar simulation and a library of Strikes for navigation functions.

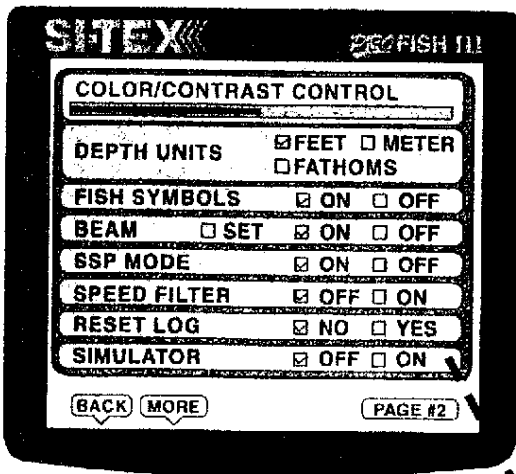



PROFISH III SIMULATOR ACCESS

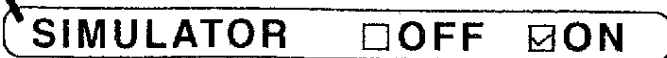

To turn the Simulator On, press **PAGE**. The Navigator screen appears, and at the bottom of it there is a balloon that says "MORE". The balloon's tail points to the **PAGE** key. Pressing **PAGE** again brings up the Page #2 list on which you can adjust Color/Contrast of the display and other controls. Press the **VIEW** key seven times (or press the **VIEW** key once, (see below) to highlight the screen band for "Simulator." Press the **VIEW** key to select "ON", and then press the **SONAR** key to see the simulator in action. The simulator always bears the icon "SIM!":



## Cursor Keys

Now is a good time to get familiar with the cursor keys - the ones arranged in a circle. These four keys, with an arrow on each one, select items from menus and adjust values for active functions. The keys have an easy wraparound scrolling feature. When you press a cursor key to scroll beyond the last item in a list, the highlighted selection starts over at the top of the list, as with the screen where Simulator is the bottom item. In other words, the shortest way from the top of a list to the bottom is to press the  cursor key once.

Observe as the Sonar screen moves from right to left. While this screen is displayed, the cursor keys may be used to adjust receiver gain and set a depth marker line without accessing any control menus. The  key increases gain and the  key decreases gain. A pop-up icon appears when either key is pressed which shows the gain setting from 0 to 20. To exit gain adjustment, do nothing. The icon will go away in a few seconds if no key presses occur. Gain does not actually work in Simulator mode.

A marker line is available to show the specific depth of a prominent feature or a school of fish. Press and hold the  key to move the depth marker line onto the screen from the upper edge of the display. The marker's depth setting is displayed at the end of the line on the right. The marker line may be positioned deeper or shallower using the  or  cursor keys. Momentarily pressing a cursor key moves the marker in small steps, and holding it down moves it in larger steps.

## Function Keys

Across the bottom of the unit are the Function keys. Each key activates a specific function with just one key press. There are no hidden function keys. Some functions have more than one page which may be viewed in turn by repeated presses of the same key. The keys step from page to page and then start over at the first one. Screen icons and information windows pop up to guide you through the available options. When there are more pages available, the "MORE" balloon will appear just above the key you use to access them. Other balloons will specify keys to press to "EXIT" a function or to go "BACK" one screen. These balloons always refer only to the top row of buttons on the unit, the ones directly under the screen balloons.

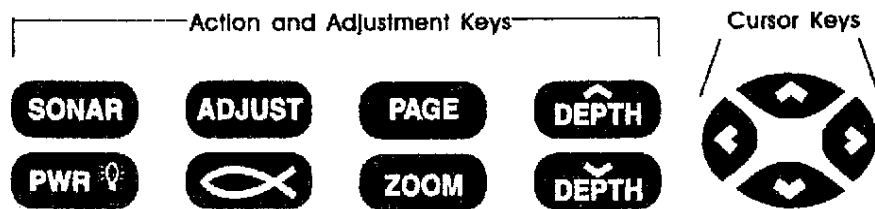

PROFISH III KEYPAD

## ZOOM

The Zoom function magnifies the main Sonar screen in four styles to show detail. The four screens wrap around, so repeated presses of the  key step through the available screens. The resolution limit on any Sonar Zoom screen is 5 feet, although the marker line will read out in smaller increments.

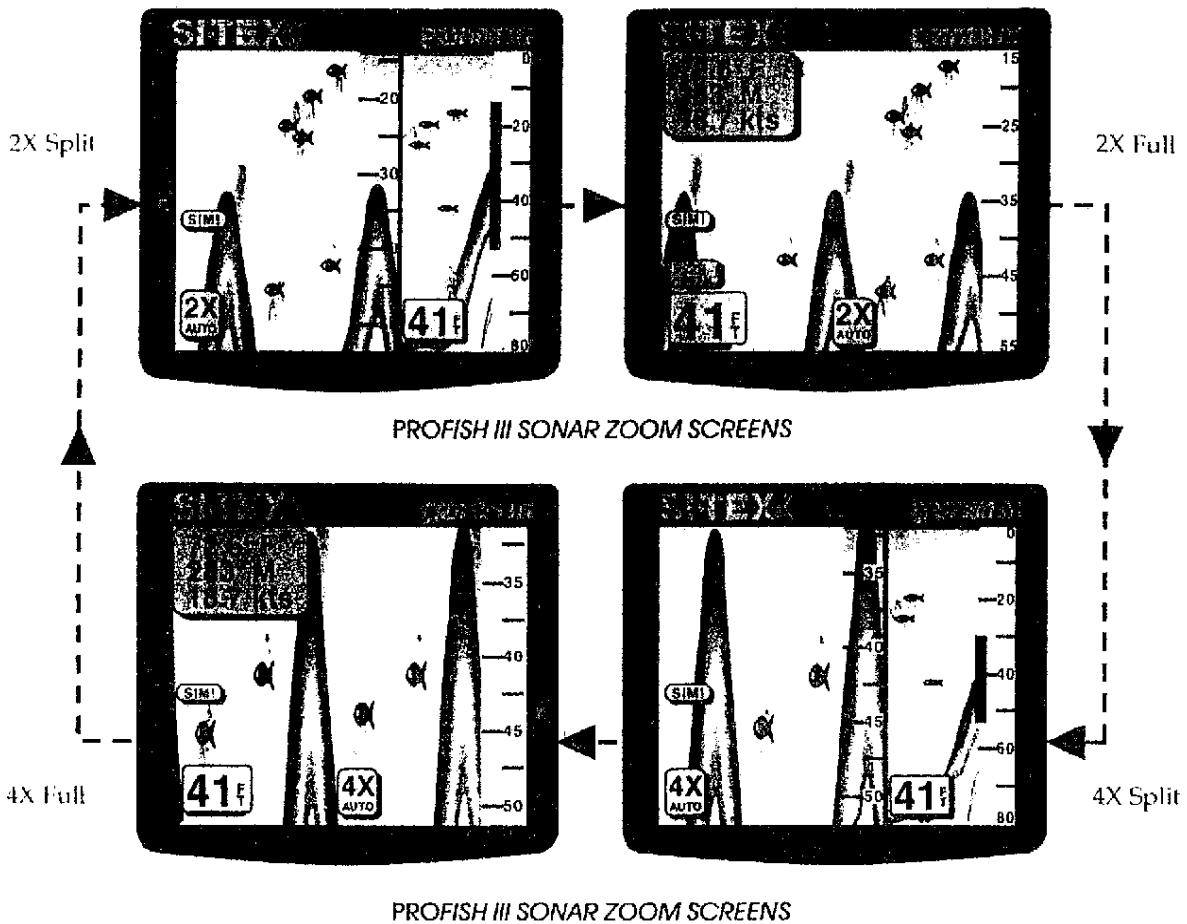

Press the **ZOOM** key. Each time the key is pressed, the next screen appears in the display. When the last screen is reached, the next press of the key brings back the first screen in the sequence. The Zoom function works in the Sonar mode 1. Try out the **ZOOM** key in the Sonar window to get familiar with the display.

The Operation Section of this manual has more detailed instructions on Sonar operation.

## STRIKE

The Strike function allows you to instantly mark a Strike so you can return to the fish position easily. When you press the **Strike** key, the track plotter is automatically activated using the Strike coordinates for the destination. The Strike screen displays your vessel's position relative to the Strike, along with steering and distance information to help you return to the position or cruise around the area.





PROFISH III STRIKE SCREEN

To mark a Strike, simply press the **FISH** key. The Plotter draws a Fish Probability Zone 200 yards in diameter around the Strike location. Initially, the plot scale is 250 yards from the center to the top or bottom of the screen. It changes to 500 yards as your vessel approaches any edge of the display. You can also press the **ZOOM** key to manually switch between 250 yards or 500 yards scale.

At the top of the Strike screen is the Steering Arrow and digital readouts indicating bearing and distance back to the Strike location. The bottom of the screen displays the depth, map scale, and balloons pointing to the keys you press to Zoom the display and Exit the Strike function. Steer your vessel to stay within the Fish Probability Zone for the likelihood of more action. Exit the Strike function to return to the Sonar screen. **When you exit, the Strike location is cleared from memory.**

When you press the **ADJUST** key to Exit, an Icon pops up to verify your Exit decision. Press **PAGE** to confirm that you want to exit (as directed by the pop-up balloons). Until you Exit the Strike function, all other keypad operations are disabled.

This completes the Getting Started session for your PROFISH III. Use the Simulator to experiment and practice using the unit. You can't hurt anything by just pressing buttons. More detailed information on all functions may be found in the Operation Section.

If not already completed, please proceed to the Installation Section.

## INSTALLATION

### Transducer Installation

The installation of your *PROFISH III*, though not difficult, does require some planning and skill to achieve the best results. It is strongly advised that you read these installation instructions completely before starting.

**CAUTION:** Mounting the transducer for your *PROFISH III* requires drilling holes into the hull of your boat which could affect its water integrity. Therefore, installation should be attempted only by qualified individuals. If you have any doubt about your ability to complete the process successfully, we recommend you obtain the services of a dealer or marine service center with knowledge and experience in transducer installation.

Since your *PROFISH III*'s Sonar performance depends upon how well the transducer is installed, please carefully observe the following mounting procedures.

For proper performance, the transducer's mounting location must be chosen carefully. The transducer must be mounted in a location that is free from turbulence and air bubbles created by movement of the boat through water. Air bubbles greatly reduce the efficiency of the transducer. It is also strongly recommended that the transducer be mounted in an area with the least amount of disturbed water passing under the transom. To determine the best mounting location, operate the boat at several different speeds and observe the water as it passes under the transom. Look for turbulence caused by the trim tabs, motor mounting, the keel, and lifting strakes.

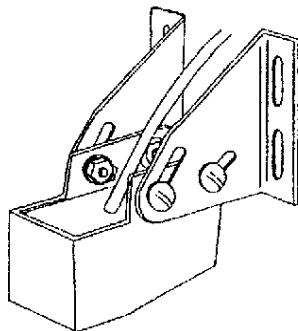

*Transom Mount Transducer*

This transducer has been designed to give you good performance installed on the transom of most boat types, however, the transom transducer style should not be used on boats with inboard engines. For boats with poor water flow under the transom or on in-boards, consider selecting a through-hull transducer. SL-TEX offers many styles of transducers.

Determine the transducer's mounting placement by referring to the steps mentioned above. For best results, the transducer's face should be level. Also, the transducer face should be mounted about 1/2 inch below the under surface of the hull. The trailing edge of the housing should be about 1/8 inch below the leading edge. The adjustable stainless steel bracket is designed to allow fine tuning of the transducer position once the installation is completed.

Route the transducer cable as far as possible away from the boat's power cables, engine controls and

other electrical cables. Do not route transducer cables near your VHF radio power or antenna cables.

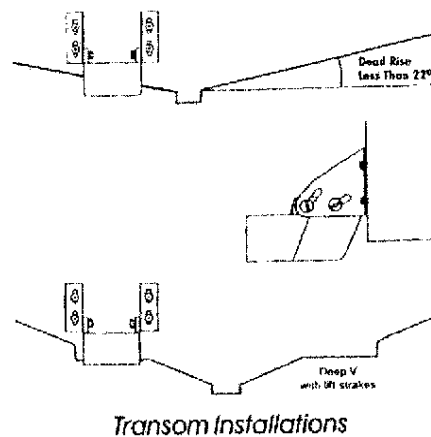

*Transom Installations*

Assemble the transducer as shown below, using the brackets and hardware supplied. Actual fastening to the hull of your boat depends upon the hull construction and hull material. If additional items must be used, be sure to obtain marine stainless steel hardware. Also, be sure to use marine waterproof sealant on all through hull fastenings. Do not use silicone RTV, since it does not have long life underwater.

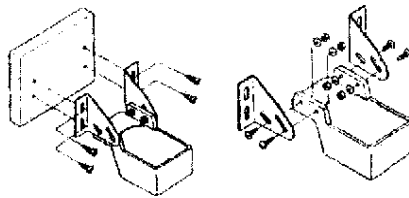

*Transom Mount Transducer Assembly*

### **Transom Transducer Maintenance**

If your boat is kept in the water, sea growth can quickly accumulate on the face of the transducer. In just two weeks in some locations, your *PROFISH III*'s performance could be affected. It is recommended that at least the face of the transducer be coated with special transducer antifouling paint. Alternatively, the entire transducer can be painted and is easier to keep clean. **Do not use regular antifouling paint.** All copper base antifouling paints are unsatisfactory and will prevent normal operation. If fouling does occur, use a stiff brush or putty knife to remove growth. Be careful not to gouge the face of the transducer. Occasional wet sanding of the transducer face is permissible with #220 grit or finer wet or dry paper. Use extra care when painting or cleaning transducers with speed sensor paddle-wheels.

Do not use solvents to clean your transducer. The high impact polycarbonate housing is very durable, but solvents will destroy it. Keep acetone, MEK, lacquer thinner, and most other thinners and solvents away from your transducer.

## Optional Through-hull Transducers

If you desire a narrow-beam, transom mount transducer with speed and temp, contact SI-TEX. Through-hull transducers are recommended for in-boards and other vessels with disturbed water flow under the transom. SI-TEX offers several models of bronze through-hull transducers. To enjoy the full capability of your *PROFISH III*, select a model with both temperature and speed sensors.

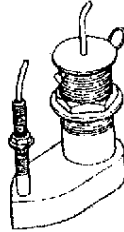

*Double Stem Through-hull Transducer*

The transducer shown has all the sensors necessary to support the advanced features of your *PROFISH III*. The small stem leads to the 200 MHz Single element transducer, and the large stem encloses the speed and temperature sensors. The speed sensor element may be easily removed and replaced with a plug to prevent leakage, for cleaning or storage. The sturdy bronze construction assures a secure installation and provides a strong base for fairing blocks if needed to compensate for hull shape.

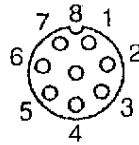
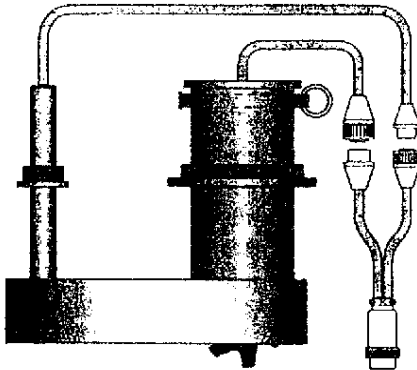

### Single Element Transducer

Brown	1	SPED SIG
Red	2	SPEED Voc
Blue	3	TD1 (+)
Bare	4	SHIELD
Black	5	TD2 (-)
Green	6	TEMP Voc
White	7	TEMP SIG
Bare	8	SPEED GND

### *Transducer with Temperature and Speed*

The transducer should be installed in a location free of bubbles and away from disturbed water flow. Smooth water flow around the transducer and along its surface are very important for consistent operation. Areas in the center third of water line length at cruising speed are usually satisfactory.

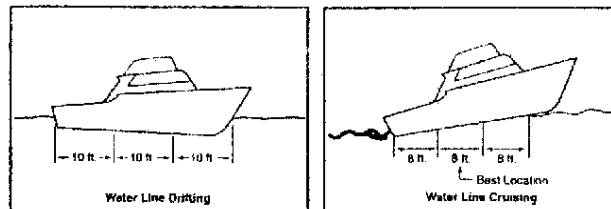

Locations forward of the engine and in a flat area near the center line of the boat are preferred. Do not install the transducer behind water intakes, other through-hull fittings or irregularities in the hull.

### Dead-rise

On hulls with dead-rise of 5° or less, the transducer may be mounted directly through the hull. Where dead-rise is greater than 5°, fairing blocks must be used to orient the face of the transducer parallel with the water surface.

#### Dead-rise Less Than 5°

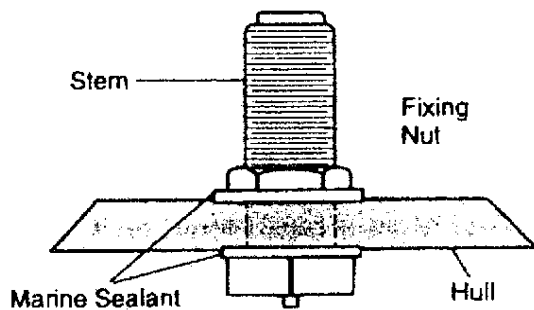

In this case, no fairing block is necessary. To prevent leakage, any gaps between the stem threads and holes drilled in the hull should be completely filled with waterproof marine sealant. Tighten the stem nuts securely but do not over tighten.

#### Dead-rise Greater Than 5°

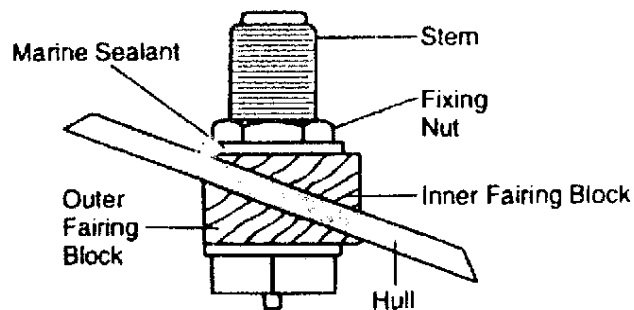

In this situation, install fairing blocks both inside and outside the hull. Install the transducer with the face aiming straight down. To prevent leakage, any gaps between the stem threads and holes drilled in the hull should be completely filled with waterproof marine sealant. Tighten the stem nuts securely but do not over tighten.

### Through-hull Transducer Maintenance

If your boat is kept in the water, performance of your PROFISH III will be adversely affected by accumulation of sea growth on the face of the transducer. To prevent sea growth effects, the face of the transducer may be coated with antifouling paint specially formulated for transducers. **Do not use regular antifouling paint on the face of the transducer.** The bronze housing may be coated with any antifouling paint. If fairing blocks are used, especially if made of wood, complete sealing prior to painting is important. Since the speed sensor is removable, it is recommended that it be removed periodically for cleaning and replaced with a plug. That way, the clean paddle-wheel sensor assures best performance.

## Display Unit Installation

Your *PROFISH III* is designed for use in the marine environment and, if carefully installed, will provide reliable service. Locate the display unit where it will have some protection from driven spray and objects that could strike the display. The LCD display window is a UV blocking plastic and will scratch if struck.

Helpful Hint: The *PROFISH III* must be positioned for direct viewing of the screen and within easy reach of the operator. The best viewing position is straight on. The viewing cone is 25 degrees to either side and 25 degrees up or down. The full color LCD display is sunlight readable and does not need to be shaded for viewing.

Your *PROFISH III* may be mounted on a flat or slanted surface console or overhead. A trunnion bracket with knobs is standard equipment, to permit easy tilt adjustments for the display unit after mounting. Any mounting surface selected must be solid and flat and capable of retaining fasteners.

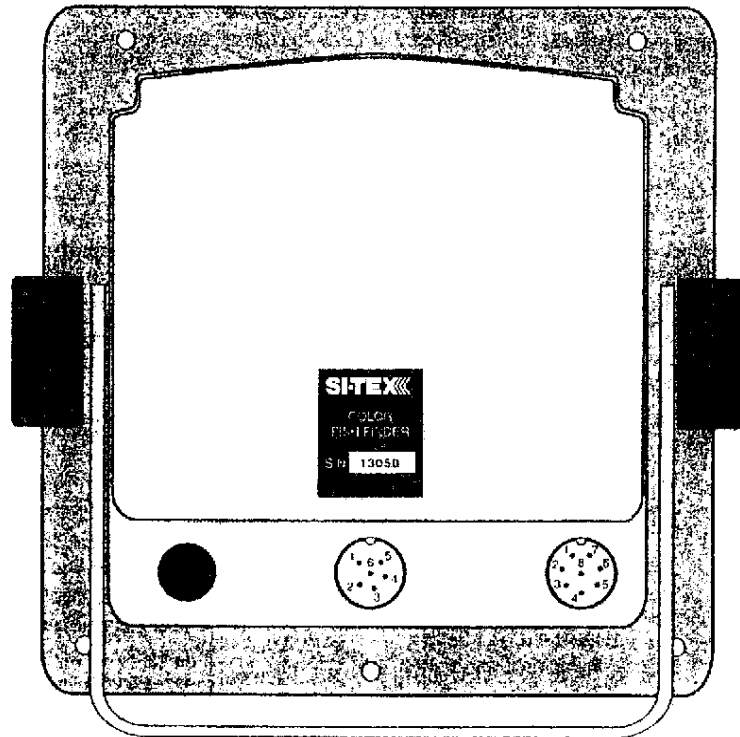

COM DATA      TRANSDUCER

*PROFISH III* DISPLAY UNIT REAR PANEL, SHOWING CONNECTIONS



## Mounting the Trunnion Bracket

Position the trunnion bracket to face the display in the desired direction and mark the locations for its mounting holes. The trunnion's base plate has an access hole which may be used if desired to pass cables from under a console to connectors on the rear panel of the display unit. The cable access hole is a double keyhole shape which allows multiple cables to pass through. If the cable access hole is to be used, trace its shape onto the console surface.

Drill holes as required to mount the trunnion. Through-bolt mount the trunnion using stainless steel machine screws, washers and nuts (not supplied). Do not use self tapping screws, because they may loosen or pull out with time and vibration. Apply marine sealant in mounting holes, install fasteners and tighten securely.

## Cable Installation and Routing

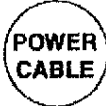
The connectors are located on the lower rear panel of the PROFISH III display unit. The connectors provide a means of supplying power, transducer and navigation devices to the PROFISH III. Each connector is keyed to prevent accidental crossed connections which may damage the unit. The connector functions and pin arrangements are shown below.

Display Unit Connector	Pin	Function	Mating Cable Wire Color
 <p>COM</p>	1	RS232 Rx	Black
	2	Spare (no connect)	White
	3	Ground	Red & Shield
	4	NMEA Rx (+) In	Blue
	5	NMEA Rx (-) In	Yellow
	6	RS232 Tx	Green
 <p>POWER CABLE</p>	1	Battery Positive (+)	Red
	2	Battery Negative (-)	Black
 <p>TRANSDUCER</p>	1	Speed Signal	
	2	Speed Vcc	
	3	Ducer (+)	
	4	Ground	
	5	Ducer Common	
	6	Temperature Vcc	
	7	Temperature Signal	
	8	Ground	

**WARNING**  
Do not plug the COM cable into Display Unit until individual wires are either terminated or insulated to prevent shorts. Damage to PROFISH III will result.

Install a 2 Amp fuse in the RED Power Lead  
**Note:** The ProFish III Power Supply is Diode protected. If the power wires are accidentally reversed, simply reverse the wiring for proper operation.

## Rear Panel Connectors

Cables should be routed to prevent accidental abuse in normal operation or maintenance activities. Protect cables from sharp edges and from crushing by heavy objects. Fuel, oil, and hydraulic fluids can attack cable jackets and leave them susceptible to water damage.

The transducer cable carries high energy pulses which can affect the operation of other electronic equipment such as VHF radios. Route the transducer cable separately from all other cables and avoid passing it through tight holes that have other cables passing through them. Transducer cables often have in-line connectors below decks. In these cases it is important to tie the cables up out of the bilge to prevent the connectors from getting wet. It is always good to have connectors at the high point in a cable run. That way if a cable gets wet, moisture runs away from the connector instead of into it.

### **Power Connection**

The *PROFISH III* operates with power input of 11 to 18 volts DC. The unit automatically shuts down if voltage exceeds 18 VDC.

When connecting the 2 meter power cable, use a fuse block with 2 Amp fuse in the positive power lead (red). If a fused power block is not available, an in-line fuse holder must be installed. Connect the negative power lead (black) directly to the battery negative power buss.

### **Transducer Connection**

Transom mount transducers have their cable permanently attached to the transducer. The connector is factory installed. To avoid cutting the cable and having to reinstall the connector, coil the unneeded cable and secure it out of the way and away from other cables. If the cable must be cut, have the connector reinstalled only by a qualified technician. Route the cable and connect it to the TRANSDUCER connector on the display unit.

Through-hull transducers have short cables with connectors factory installed. An extension cable is used between the transducer and the display unit. Join the connectors near the transducer and install the rubber boot to protect the connectors from moisture. Route the extension cable to the display unit and connect it to the TRANSDUCER connector.

### **Data Connection**

The COM DATA connector on the display unit provides data interface to GPS or Loran navigation devices. The navigation devices send geographic position, speed, course and other information to the *PROFISH III* for use with the Strike function and the information displayed on Sonar screens. The optional 1-meter DATA cable for your *PROFISH III* has a molded 6-pin connector factory installed on one end. Refer to the connector diagrams above. The other end has leads which may be connected as required to connectors provided with, or available for, your navigation device.

When making connections, make sure wire ends do not touch each other or short to other wires or objects.

Refer to the manual for your navigation device for the appropriate connections. More information about data interfacing is presented in the Reference Section of this manual. The data interface is not necessary for Sonar operation.



## OPERATION

This section describes in detail all the operating features and functions of your *PROFISH III*. Please review the following illustration for the locations and uses of function keys. In this section, information boxes appearing in the display are called Icons.

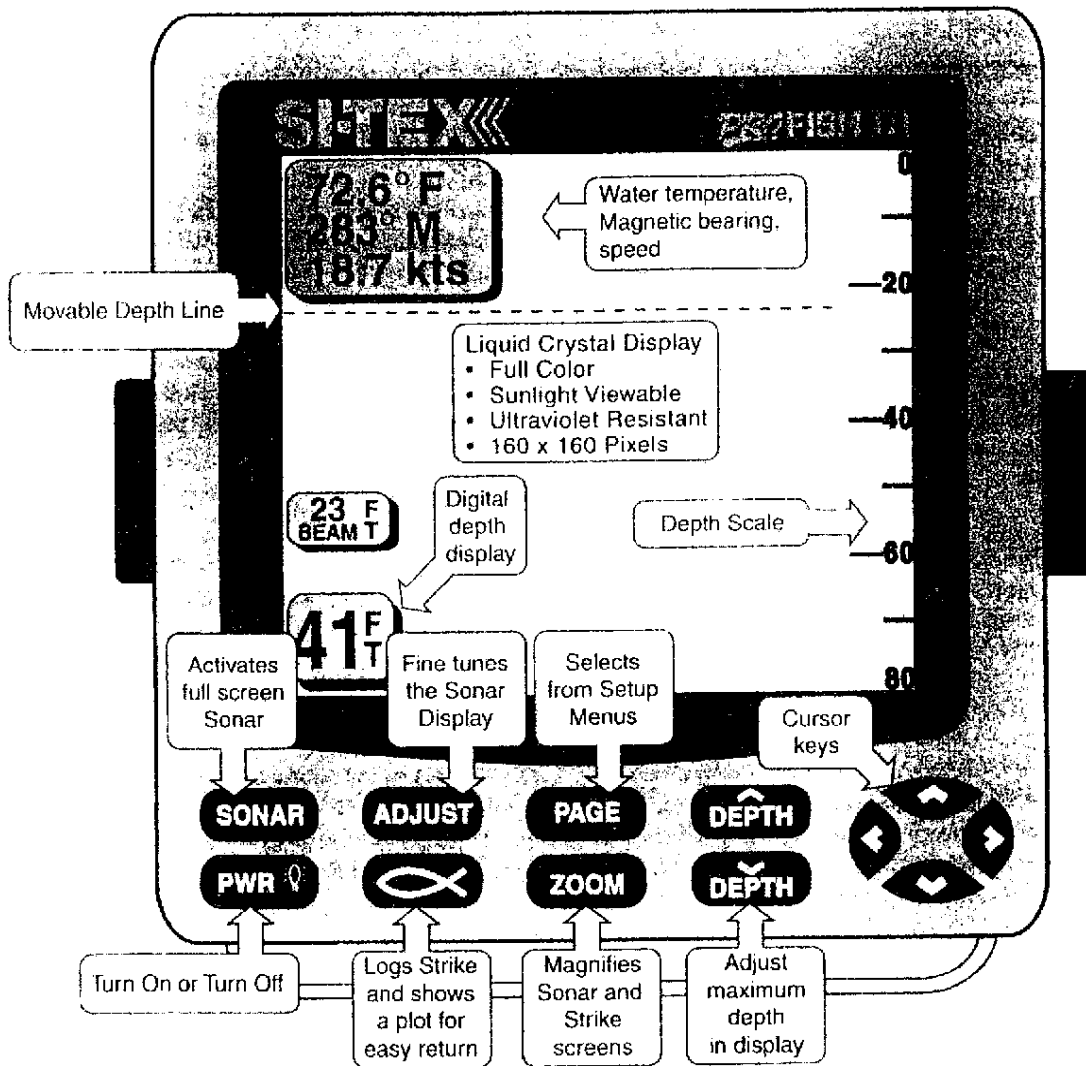

PROFISH III FRONT PANEL FEATURES

### Action and Adjustment Keys

The Action and Adjustment Keys across the bottom of the unit select the *PROFISH III* operation you want to see in the display. Each key activates a specific function with just one key press. There are no hidden

function keys. Some functions have more than one page which may be viewed by repeated presses of the same key. These step through page by page and then start over again at the beginning. Just follow the pop-up screen icons to guide you through proper operation. In many ways, operation of the *PROFISH III* is similar to your personal computer, with windows and icons presenting explanations and defining options.

### Cursor Keys

The four cursor keys select items in menus and change or adjust values for an active function. When repeated presses or holding down one key scrolls beyond the last item in a list, the highlighted selection starts over at the opposite end of the list. For example, the shortest way from the top of a list to the bottom is to press the  cursor key once. Normally the Left and Right arrow keys control gain and the Up and Down keys control the marker line.

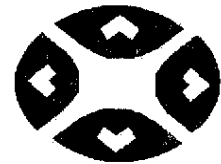

### SONAR

The main Sonar screen is the primary display for the *PROFISH III*. A Sonar screen also appears in the background of most other displays so you can keep an eye on fish or the sea bottom while you use other functions.

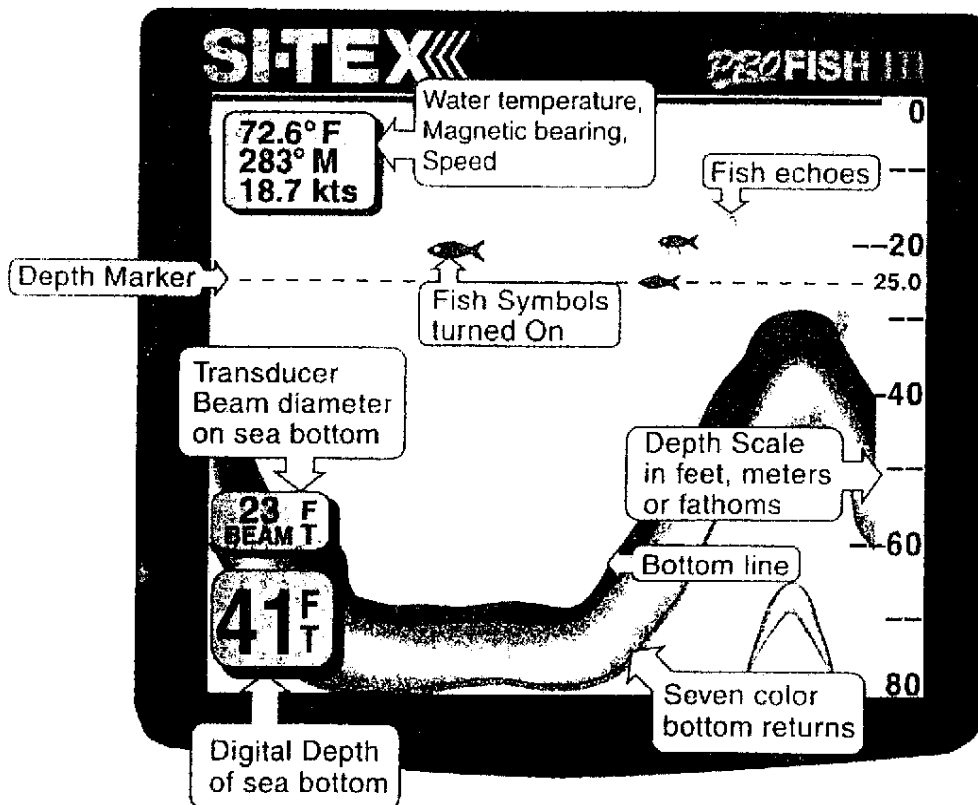

PROFISH III SONAR SCREEN

The arrow boxes show the many features of the main Sonar screen. The Status Icon may be turned off or on from Page #3. Press **PAGE** three times and select Sonar Data Box to OFF.

You may set the Beamwidth of the transducer you are using to display accurate beam diameters. This selection is with the SET function. This does not alter the transducer in any way. The Beam Icon and Fish Symbols may be turned On or Off from Menu Page #2.

To change the Depth setting, press the **PAGE** and **DEPTH** keys. The Depth Scale changes in small steps. The minimum depth is 5 feet, and the range increments in 5-foot steps. Depth units may be set to feet, meters, or fathoms from Menu Page #2 (Press **PAGE** twice).

The Digital Depth Icon always shows the depth of the sea bottom even if it is beyond the maximum depth shown on the Depth Scale.

Sonar Gain control is very important to detecting fish and sea bottom features. To adjust Sonar Gain, press the **+** key to increase gain and the **-** key to decrease gain. When either key is pressed, an Icon appears in the display showing the gain as a percentage from 0 to 20 steps. To stop setting gain, just do nothing. After several seconds the Icon disappears. The arrow keys bring it up again if you need it. Adjust the Sonar Gain for good contrast between the bottom line and the colored areas of the sea bottom. Press and hold a key to step settings faster.

The Depth Marker may be used to mark the depth of a prominent feature even after it has moved off the screen. The Depth Marker is visible only on the main Sonar screen. To set the Depth marker, press and hold the **MARKER** key to move the marker onto the screen. Press the **MARKER** key to set the marker to a shallower depth or to park it at the top of the main Sonar screen. Momentary key presses move the marker in small steps. Hold the key down to move it in larger steps. A digital readout of the depth marker line appears at the right of the display.

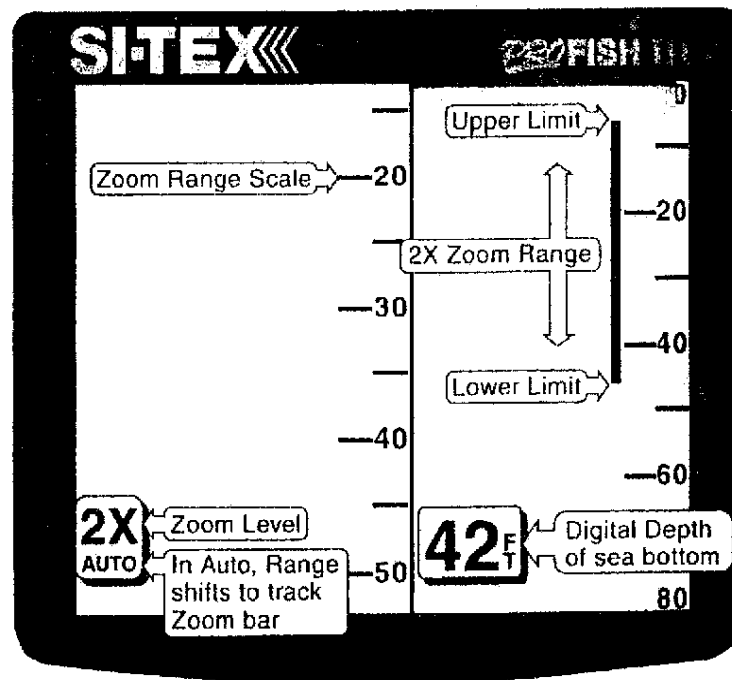

PROFISH III  
ZOOM SCREEN  
BASICS

## ZOOM

The Zoom function magnifies the main Sonar screen to show more detail.

There are four displays. The Zoom key sequences through these four screens. To Zoom the display to the next screen, press **ZOOM**. The 2X Split Zoom screen is the first of four Sonar Zoom screens. The right side of the split screen is the main Sonar screen and the left side is 2X magnified. The arrow boxes show the important features of the Sonar Zoom screens.

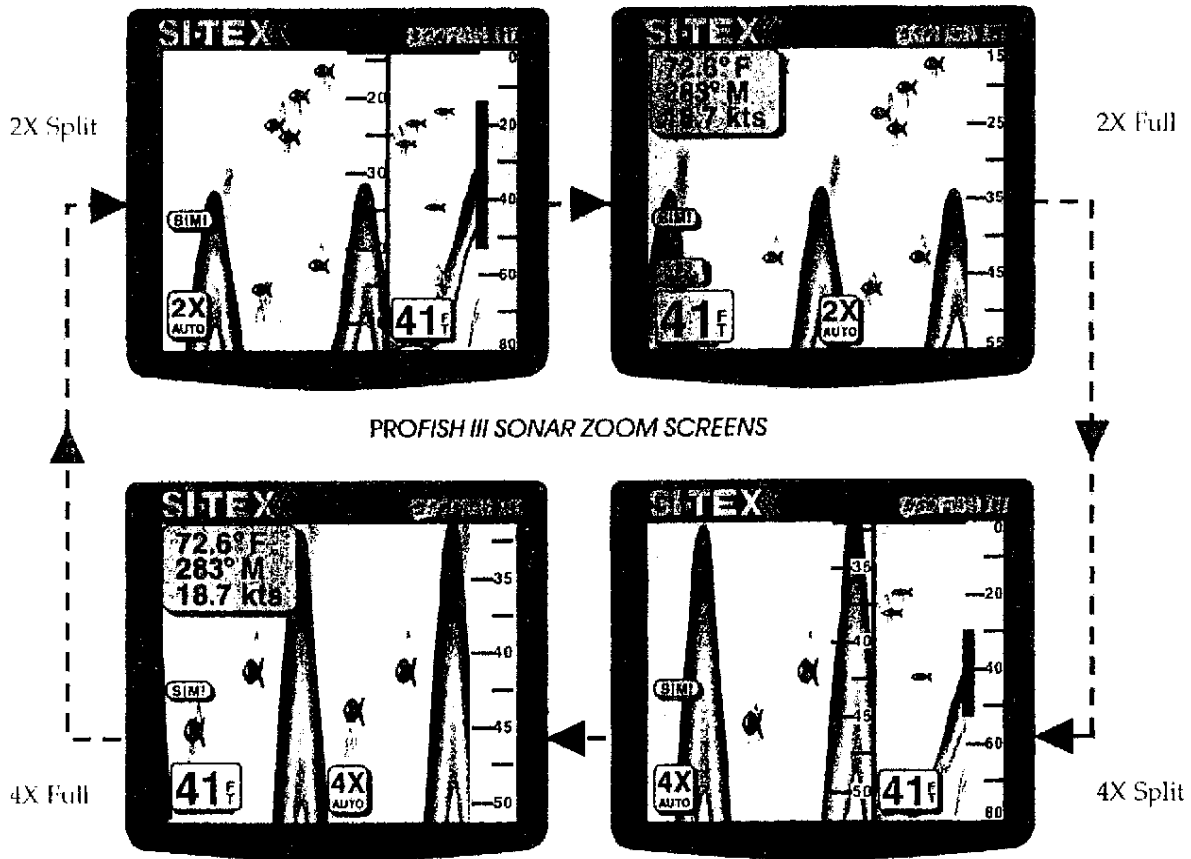





The Zoom Range bar indicates the exact portion of the main Sonar Depth Range that is magnified in the 2X side of the screen. If AUTO is indicated in the Zoom Level Icon, the Zoom Range bar tracks the sea bottom and the magnified sea bottom is always in view on the 2X side of the screen. The other Zoom screens are 2X full screen, 4X split screen and 4X full screen.

Zoom cannot magnify to less than 5 depth units full screen, therefore the main Sonar Depth Range must be set to 10 depth units or greater for 2X Zoom and 20 units or greater for 4X Zoom.



To return to the main Sonar screen, press the **SONAR** key.

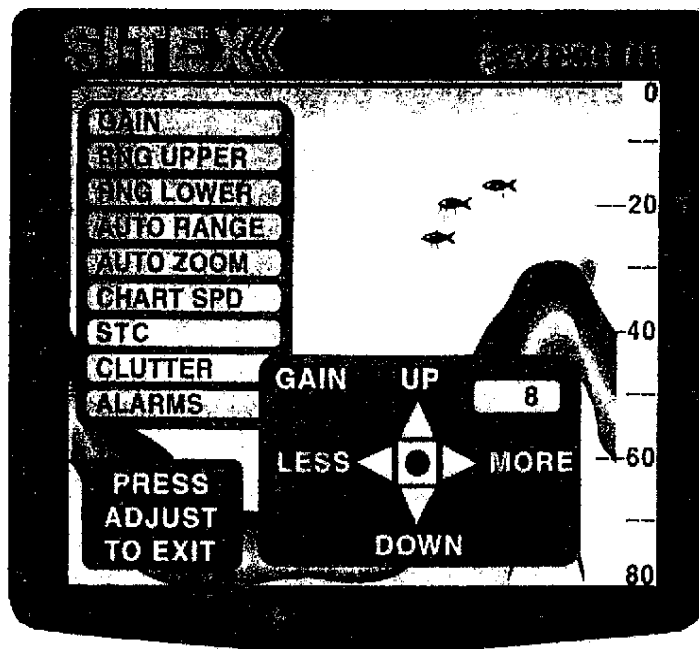

## ADJUST Sonar Menu

More options for fine tuning the Sonar function are found on the Sonar Adjust menu. To view the Sonar Adjust menu, press the **ADJUST** key. Use the  or  cursor keys to scroll to and highlight a menu item. Use the  or  keys to adjust the item to your liking. When some items are selected, Icons appear in the screen that show specific information about the highlighted item or point to keys to be used for additional adjustment. Simply follow the instructions that appear on the screen. Press the **ADJUST** key to exit, as directed by the on-screen icon.





## PROFISH III SONAR ADJUST

**GAIN:** Controls the Sonar receiver gain setting from this menu. You can also use the  or  keys to set Gain when the Sonar screens are displayed.

**RNG Upper:** ("Range Upper") Adjusts the upper depth setting for the display in small steps. Use the  and  keys to change the setting. The cursor keys continue to select other items from the Sonar Adjust menu. Reset to 0 (zero) by pressing the **PAGE** key.

When RNG Upper is not zero, Auto Range operation is cancelled.

**RNG Lower:** ("Range Lower") Adjusts the lower depth setting in the display in small steps.  and  change the setting.

**AUTO Range:** When set to AUTO, depth range changes automatically to keep the sea bottom displayed in the center third of the screen. A vertical line appears in the display at each change of the depth range. A quick 3-beep error tone is emitted if you try to place the Depth Scale above the bottom. When set to MANUAL mode, the upper and lower depth range must be set by the operator and only those objects and sea bottom falling within the set depth range are displayed.



**AUTO Zoom:** When set to AUTO, the magnified portion of the Sonar display tracks the sea bottom. In MANUAL mode, the zoom range is fixed and only those objects falling within the length of the zoom bar are magnified.

**Chart Speed:** Adjusts the rate of movement of the Sonar display from right to left. The speed settings are: 2X, 1X, 1/2X, 1/4X, 1/8X and STOP.

**STC:** Means Sensitivity Time Control. STC controls the gain of the receiver during the interval starting immediately after each sonar pulse is transmitted. Set STC to reduce or eliminate excessive sonar returns near the surface.

STC may be set in steps from 0 to 20, with 10 as the default setting. Too high a setting reduces gain and may cause loss of fish echoes.

**Clutter:** Allows reduction in the number of color levels displayed on Sonar screens. It is used in highly turbulent water conditions such as in passes and inlets. There are 7 levels possible and 6 of them can be turned off if desired. The strongest echoes are displayed as level seven (red) and the weakest as level 1 (green).

**Alarms:** There are three alarms, Fish, Shallow, and Deep. These are controlled by the Alarms item in the Adjust menu. When you select this menu, the  and  cursor keys step through the available alarms. Other keys change the settings and turn the alarms on or off, as described below.

The **Fish Alarm** sounds an audible alarm and displays the Fish Icon when fish are detected. Use the Left/Right cursor keys to select the size of fish, small, medium or large, that will sound the alarm. Use the  key to turn the alarm On or Off as indicated in the Icon that appears. You will surely enjoy the giant gold fish icon that appears when you have found your best fishing spot.

The **Shallow Alarm** can be set to sound and display an alert if the bottom becomes shallower than the setting. When the alarm is set, a vertical bar appears in the Depth Scale extending from the top of the screen down to the alarm depth. Use the cursor keys to set the depth and the  key to turn the alarm On or Off.

The **Deep Alarm** is of course the opposite of Shallow. It sounds and displays an alert if the bottom becomes deeper than the setting. When this alarm is set, a vertical bar appears in the Depth Scale extending from the bottom of the screen up to the alarm depth. Use the cursor keys to set the depth.  turns the alarm On or Off.

## **STRIKE**

The Strike function allows you to instantly mark a Strike. A plotter screen is automatically activated using the Strike coordinates as the destination and displays your vessel's position relative to the Strike. There is only one Event for Strikes so the next Strike overwrites the previous one.

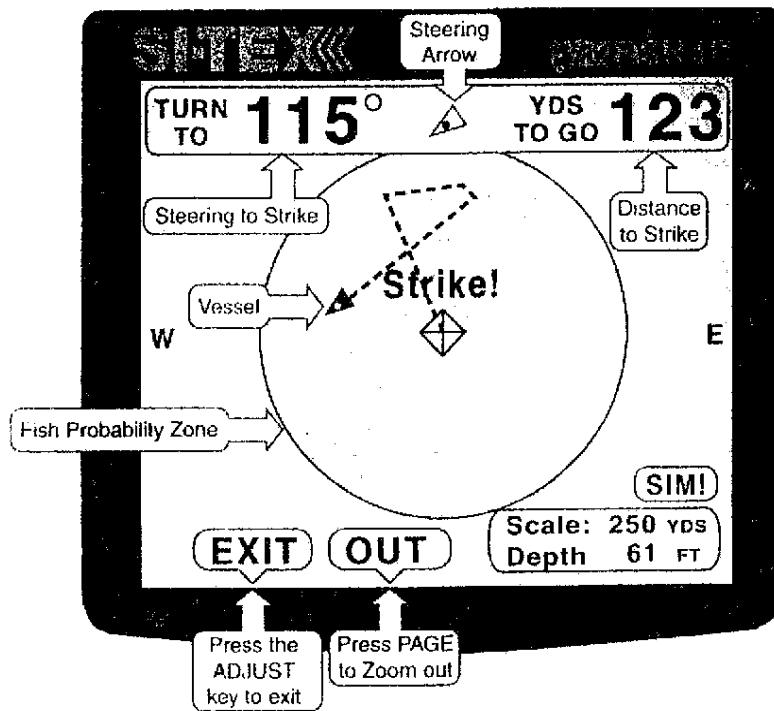

### PROFISH III STRIKE SCREEN

To mark a Strike, press the **⊗** key. The Plotter draws a Fish Probability Zone 200 yards in diameter around the Strike. Initially, the Plotter's scale is 250 yards from the center to the top or bottom of the screen and changes to 500 yards as your vessel approaches any edge of the display. The scale is in meters if metric distance units are selected.





Press the **zooM** key to manually switch between 250 yards or 500 yards scale.

Displayed at the top of the screen is the Steering Arrow and digital readouts indicating bearing ("Turn To") and distance back to the Strike. At the bottom of the screen are the depth, map scale and Icons pointing to keys for zooming the display in or out, and Exit. Steer your vessel to stay in the Fish Probability Zone for the likelihood of more action.

If the Fish Alarm is turned on, a Fish Icon appears in the Strike Screen, alerting you to the presence of fish in the area.

When you press the **ADJUST** key to Exit, an Icon pops up to verify the Exit decision. Until you Exit the Strike function, all other keypad actions are disabled.

## MENU Page Screens

A selection of screens let you customize the functions of your *PROFISH III* by selecting options from menus displayed on the screen. There are four Pages, sequenced by pressing the **PAGE** key. Each time the key is pressed, the next Menu screen appears. The first one is the Nav widow, as just discussed. Pressing **PAGE** again brings up the configuration menus. Within a setup screen, use the  and  keys to select the highlighted menu item. Use the  or  keys to change the menu's setting. When some items are selected, Icons appear, showing specific information about the highlighted item or pointing to keys to use for additional adjustment.

## NAV DATA (Page #1)

The Nav function presents steering and speed information in text format with some data presented graphically. The **PAGE** key toggles its screen to the front, and repeated presses of the **PAGE** key bring up the other pages in sequence. The Nav function provides a split screen view of both navigation and Sonar. The Zoom and Left/Right cursor keys (for gain) control the Sonar portion of the display in the normal way.

Press the  key to toggle between speed and Log Distance display in the speedometer's center data box.

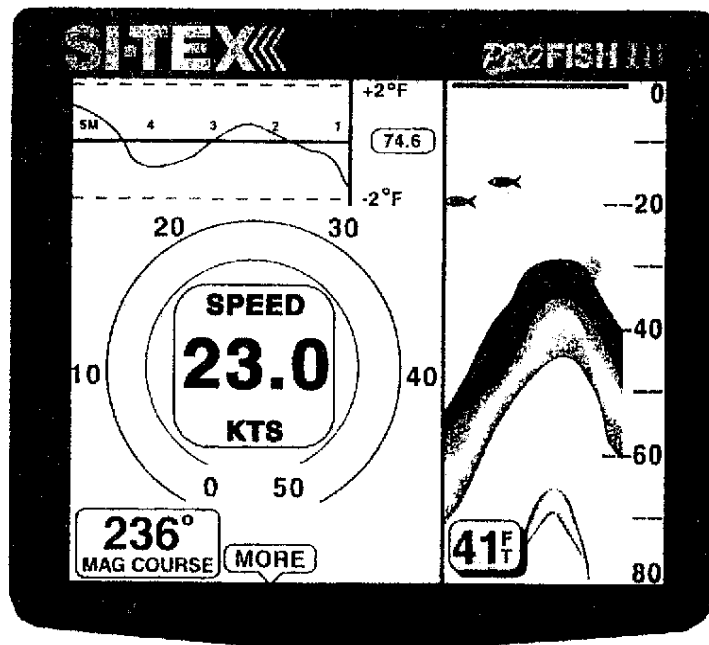

PROFISH III NAV DATA WINDOW



The Navigation Data Window presents the following information:

**Temp:** Water temperature is displayed in degrees Fahrenheit or Centigrade. The unit of measure is selected from Menu Page 2 (Press **PAGE** twice). An automatically centered plot of water temperature history over the last 5 minutes is presented. If the temperature changes more than 2 °F or °C, the entire graph auto-shifts to the center.

**MAG COURSE:** This is your vessel's current magnetic Course Over Ground. It matches your compass when you are moving.

**SPEED kts:** Displays your Speed Over the Ground (SOG) if speed data is obtained from a navigation receiver or Speed Through the Water (STW) if speed data is obtained from the paddle-wheel. Select speed data source from Menu Page 3.

The circular display is an analog "speedometer" that displays your vessel's speed graphically. The default setting is GPS.

## Menu Page 2 (Control)

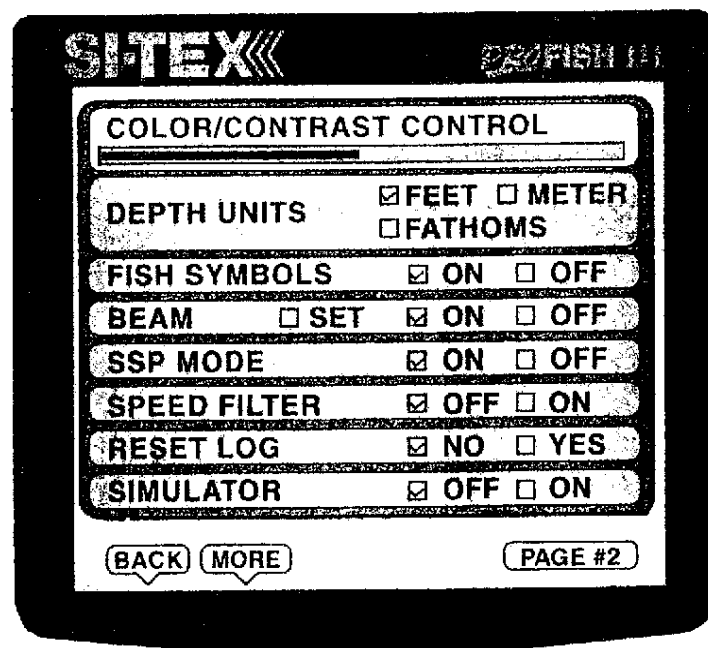

PROFISH III MENU PAGE 2 SCREEN

**Color/Contrast Control:** The moving bar graph has a 32 step adjustment range. Moving the bar to the left deepens the contrast and colors while moving it to the right lessens it. The control allows optimum viewing under all lighting conditions. The effect of your adjustments are shown in the Color/Contrast bar.

**Depth Units:** Selects the Depth Unit of measure to Feet, Meters or Fathoms.

**Fish Symbols:** Turns the Fish Symbols On or Off. If turned On, Fish Symbols appear in Sonar displays when echoes which meet the selection criteria are detected. There are 3 sizes of Fish Symbols and each size is a different color. The PROFISH III places the fish symbols over the echoes for an enhanced view of the actual echo plus the fish ID.

**Beam Display:** Turns the Beam Icon On or Off. When turned On, the Beam Icon appears in the main Sonar screen and displays the diameter of the beam cone on the sea bottom. You can use the SET option to adjust the beamwidth's display. Changing this setting has no effect on the transducer itself, but affects only the calculation for the display.

**SSP Mode:** Turns Surface Signal Processing On or Off. SSP suppresses the surface noise caused by the transmitted main sonar pulse.

**Speed Filter:** Selects a filter to smooth variations in speed. This is especially useful when trolling at low speed (under 4 knots) and using the paddle-wheel speed sensor. The Speed Filter has a 3 second smoothing

**Reset Log:** Used to reset the log of distance traveled. When you select Yes, the log data is reset to 0 (zero) immediately, the selection reverts to No, and the log now begins to accumulate.

**Simulator:** Turns the Simulator On or Off. The simulator may be used to become familiar with PROFISH III features and operation without connecting a transducer or navigation receiver. Sonar, Plotter and Nav functions are simulated.

### Menu Page 3 (Control)

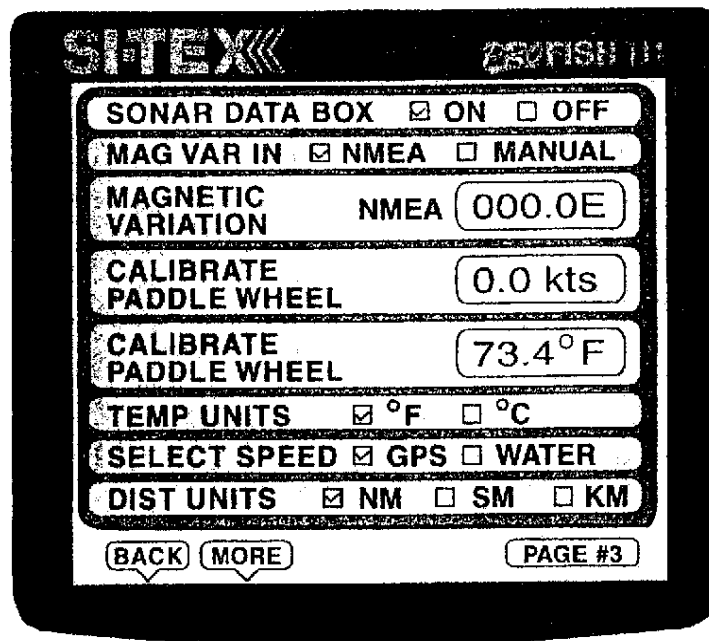

PROFISH III MENU 3 SCREEN

**Sonar Data Box:** Turns the Sonar Data icon on or off on the Sonar Screen.

**Magnetic Variation:** Lists two sources for magnetic variation. Select either NMEA data from a navigation receiver or manual input. In Manual, use the cursor keys to enter variation in 0.1° steps East or West.

**Calibrate Paddle Wheel:** Provides a data Icon for manual input of correction values to offset inaccuracies in Paddle-wheel Speed installations. Use the cursor keys to enter values to match a known correct value. Thereafter, the corrections are stored in memory and applied to displayed values. Corrections are a percentage plus or minus. Match the setting to your GPS speed, if you wish.

**Calibrate Temperature:** Provides a data Icon for manual input of correction values to offset inaccuracies in Temperature sensing. Use the cursor keys to enter values to match a known correct value. Thereafter, the corrections are stored in memory and applied to displayed values. Corrections are entered in tenths of degrees, plus or minus.

**Temp Units:** Selects the Temperature Unit of measure to either degrees Fahrenheit or Centigrade.

**Select Speed:** Selects the source for speed data which is displayed, either GPS or water.

**Dist Units:** Choose the display unit of measure of distance, nautical miles (NM), statute miles (SM) or kilometers (KM).

#### MENU PAGE #4 (GPS)

The screenshot shows the GPS screen of a SITEX PROFISH III device. At the top left is the 'SITEX' logo and at the top right is 'PROFISH III'. The main display is a table with four columns: SAT, AZIMUTH, ELEVATION, and SNR. A 'GPS FIX 3D' indicator is overlaid on the table. Below the table is a 'SIM!' indicator. At the bottom, there are fields for coordinates (N 28° 53.838', W 082° 42.431'), DOP: 1.19, and UTC: 14:43. Navigation buttons 'BACK', 'MORE', and 'PAGE #4' are visible at the bottom.

SAT	AZIMUTH	ELEVATION	SNR
22	025	78	46
29	084	78	46
14	255	46	36
25	058	34	36
16	301	28	42
03	155	28	41
01	128	14	38
18	316	05	29
31	185	05	00
06	041	04	00

GPS  
FIX  
3D

SIM!

N 28° 53.838'      DOP: 1.19  
W 082° 42.431'      UTC: 14:43

BACK   MORE      PAGE #4

PROFISH III GPS SCREEN

## GPS PAGE

Page #4 lists items relative to the GPS navigation data the unit displays. An NMEA compatible GPS receiver must be connected and operating. The screen appears when you press **PAGE** four times.

Your vessel's present position is displayed in latitude and longitude at the bottom of this screen. If there is no GPS receiver, or if it's not connected or working, dashes appear in all position indications on all screens.

The chart across the middle of the screen is a readout of the satellites' azimuth, elevation, and signal strengths that your GPS receiver is reporting. This menu presents specific satellite information from a GPS navigation receiver connected to your *PROFISH III*.

**GPS FIX** (the balloon in the middle of the screen): Displays the type of position fix. Fix may be 2D, 3D, 2D Diff, or 3D Diff. At least three satellites must be received and tracking to provide a 2D, latitude and longitude, fix. Four satellites are required for a 3D fix - latitude, longitude and altitude. To add differential precision to either type of fix requires a differential beacon receiver connected to the GPS receiver.

**Sat:** Displays the satellite identification number.

**Azimuth°:** Displays the position of a satellite in degrees from North.

**Elevation°:** Displays the position of a satellite in degrees above the horizon.

**SNR:** Signal to Noise Ratio. Displays the relative quality of signals received from a satellite. Actual values differ between GPS manufacturers. Higher values are better than low values.

**N / S:** Indicates the North or South hemisphere designation followed by the latitude coordinate.

**E / W:** Indicates the East or West hemisphere designation followed by the longitude coordinate.

**DOP (Dilution of Precision):** Displays the quality of a fix as affected by the geometry of satellite positions. A DOP value of 2.0 or less is excellent.

**UTC:** Indicates Universal Coordinated Time, also known as Greenwich Mean Time or the time at 0 (zero) degrees longitude.

## SI-TEX PROFISH III COLOR FISHFINDER SPECIFICATIONS

Case Size (w/o Trunnion)	5.4"W x 6.3"H x 3.4"D.
Case Construction	UV Stable molded ABS.
Waterproof	CFR-46.
Weight	Less than 2.5 lbs.
Mounting Options	Standard Trunnion (Deck Mount or Overhead Mount).
Connectors	Power Cable - removable 8 Pin Transducer 6 Pin COM Port.
Temperature	0° to 55 °C ambient; direct sunlight operation 100% OK.
Display Technology	160 x 160 Pixels High Contrast STN Transflective Birefringent 8 Color LCD.
LCD Temperature	0° to 70 °C.
LCD Viewing Angle	UP/DOWN 50° total (typical). LEFT RIGHT 50° total (typical).
Pixel Size	0.36 mm by 0.36 mm.
Power Requirements	11-18 VDC @ 5 W maximum.
Transducer Frequency	200 kHz Transom Mount with optional Speed and Temp; other optional styles available.
Transducer Beamwidth	18° standard.
Transducer Output Power	200 W RMS (1600 W P-P).
Display Modes	SONAR Standard FF Screen (home screen). ZOOM 2X & 4X Zoom capability with both Split and Full Zoom Screens. Auto or Manual Zoom with depth indicator ZOOM bar. PAGE 4 Pages are included: · Auto-centering Temp Graph Screen with Circular Speedometer Graph displaying Paddlewheel or GPS Speed/LOG data. Split FF working · 2 Pages of adjust screens to customize settings · GPS Status Screen ADJUST FF Adjust Screen with Cursor editing. STRIKE Direct Course Line Tracking to STRIKE position with 250-yard Strike Zone area displayed. Automatically Zooms out to 500 yards.

Depth Ranges	0-600' depth in 5' steps, 1 Fa steps, or 1 M steps. Upper and Lower Range sets can be set to any depth interval in 10' increments.
Digital Depth Display	Digital Depth Box displayed
Depth Line Indicator	UP/DOWN Cursor control in Sonar Mode displays a dashed depth line anywhere on the screen with digital readout.
Depth Cone Display	Displays actual diameter of Transducer Beam on the bottom
Auto Zoom	ON/OFF. Scale does not shift, complete FF picture shifts.
Image Speed	2X, 1X, 1/2X, 1/4X, 1/8X, and Stop.
Depth Alarms	Shallow and Deep.
Fish Symbols	3 sizes, each a different color; ON/OFF.
Fish Alarm	Audible and visual with a time-out.
Temperature Graph	±0.2° resolution.
Data Window	Temp, COG and SOG.
Input Format	NMEA 0183 V1.5 or V2.0+.
Gain Control	20 steps, manually variable
STC Control	20 steps.
Color Rejection (Anti-clutter)	Up to 6 levels.
EL Backlight Control	4 steps.
Keypad lighting	ON/OFF.
Power Down Timer	3 seconds delay holding the POWER key.
Simulator	FF & STRIKE.

## REFERENCE

### Care and Cleaning

Your *PROFISH III* is made to withstand marine elements but a little care ensures a trouble free life. Accumulations of salt and sand, if not removed, will eventually mar the finish. No solvents or harsh cleaners should be used. The display unit may be wiped down with a damp cloth while avoiding the display screen. Be careful not to scratch the display surface. Gently remove any sand or other grit particles before cleaning the display screen. The display screen should be cleaned only with eyeglass lens cleaner and a clean soft cloth using very light pressure.

### NMEA

A standard developed by the National Marine Electronics Association and used by most marine equipment manufacturers for data communication is known as NMEA 0183 version 1.5 and version 2.0. NMEA 0183 specifications offer many recognized sentences for exchanging data between many types of marine equipment. The following technical information is provided for reference and is accurate to the best of our knowledge at the time of printing. Please refer to the appropriate NMEA specifications for full details and the latest information.

The data sentences used by the *PROFISH III* are as follows.

#### Input Sentences, Version 1.5 and 2.0:

xxGGA, xxGLL, xxGSV, xxRMA, xxRMC, LCGTD

#### NMEA data interface characteristics:

Baud rate	4800
Data bits	8
Parity	None
Stop bits	2
Character Code	ASCII
Voltage Level	0-5V
Sentence recurrence rate:	2 seconds.

Do not operate the *PROFISH III* Simulator while under way.

## Troubleshooting

Your *PROFISH III* is a high quality, precision, electronic device capable of service in the marine environment. To assure dependable performance, careful installation and reasonable care are required. If problems develop or if performance appears degraded, perform a thorough inspection of the Transducer, Display Unit and all cables and connections. Look for signs of moisture intrusion, cuts in cable jackets and corrosion on connector pins.

With all of *PROFISH III*'s flexibility, it is possible that an abnormal combination of settings could possibly affect performance. Restore the unit to factory settings and then turn On the Simulator to verify Display Unit performance.

To restore factory default settings, press the **PWR** key and then press the **☉** key while the Self Test screen is displayed. The unit resets and after Self Test, the Sonar screen is displayed.

To view full screen color bars, press the **PWR** key and then press the **DEPTH** key while Self Test is displayed. Eight color bars are displayed. Press the **☉** key to see the colors move across the screen.

To proceed, press **DEPTH** again.

The table below lists some possible problems and remedies.

If problems persist, contact your authorized SI-TEX customer service station.

SYMPTOM	INSPECT/TEST	POSSIBLE CAUSE
Unit does not turn On	Check voltage at power connector, polarity at battery.	Blown fuse, dead battery, reversed power cable.
No Sonar	Check transducer connector and cable, transducer setting Menu 1	Wet connector, cut cable, damaged transducer, incorrect transducer selection.
Weak Sonar	Check Gain, STC, Clutter Rej setting, transducer	Improper settings, marine growth on transducer.
No Position Data	Check COM connector, GPS/Loran power, Menu 2, Menu 3 settings	Navigation receiver inoperative, no NMEA, Improper Menu selections.
No Temperature, erratic or incorrect Temperature	Menu 3 setting, transducer connector and cable	Faulty sensor or cable, wet connector
No Speed, erratic Speed Unit does not turn Off	Menu 3 setting, paddle-wheel, GPS/Loran Press and hold power key 10 to 15 seconds, disconnect power connector	Stuck paddle-wheel, cables, Navigation receiver setting. If persistent, service is required.