



KODEN

INSTALLATION MANUAL

ECHO SOUNDER

«DIGITAL»

CVS-702D

CVS-702D Installation Manual**Doc No. 0092607022****Document Revision History**

No.	Doc. – Rev. No.	Date Revised (Y/M/D)	Revised content
0	0092607022-00	2015/11/11	First edition
1	0092607022-01	2016/09/05	Configuration of Equipment, Chapter 3
2	0092607022-02	2016/12/20	Specifications
3	0092607022-03	2017/04/13	Chapter 1
4	0092607022-04	2019/10/31	System Configuration, Configuration of Equipment, Chapter 2
5	0092607022-05	2022/10/20	Chapter 1, Cover
6			
7			
8			
9			
10			

Document No. Revised Version Norm

When part of the document needs to be revised, the document has advanced revised number. The document No. is indicated at the lower right side on the cover and at the left or right side of the footer region of each page.

© 2015-2022 Kodan Electronics Co., Ltd. All rights reserved.

No part of this publication may be reproduced, transmitted, translated in any form by any means without the written permission of Kodan Electronics Co., Ltd. The technical descriptions contained in this publication are subject to change without notice. Kodan assumes no responsibility for any errors, incidentals or consequential damages caused by misinterpretation of the descriptions contained in this publication.





Important Notice

- For copy and transcription of this Installation Manual (hereinafter referred to as this manual), permission from Koden is needed. Koden prohibits the un-authorized copy and transcription of this manual.
- If this manual is lost or damaged, consult a dealer of Koden or Koden.
- The specification of the products and the contents in this manual are subject to change without notice.
- The contents displayed on the menu of product may be different from the expression of this manual. The fonts and shapes of the keys and menus in the illustration may differ from the actual ones, and some parts may be omitted.
- Koden is not liable for damages and troubles arisen from misunderstanding of the contents in this manual.
- Koden is not liable for any damages caused by earthquake, lightning, wind and flood damage and fire for which Koden is not responsible, and actions by third parties, other accidents, customer's unintended error/abuse and the use under other abnormal conditions.
- Koden is not liable for damages of accompaniment (change/loss of memorized content, loss of business profit, stop of business) arisen from use or failure of our products.
- If the stored data are changed or lost, irrespective of causes of troubles and damages, Koden is not liable for them.
- Koden is not liable for any damages arisen from malfunction caused by combination of software and connected equipment in which Koden is not engaged.



For Your Safe Operation



Symbol used in this Installation Manual

The following graphical symbols are used in this manual. The meaning of each symbols shall be well understood and apply at maintenance and inspection works.







Symbol	Meaning
 Warning	Mark for warning This symbol denotes that there is a risk of death or serious injury when not dealing with it correctly.
	Mark for danger high voltage This symbol denotes that there is a risk of death or serious injury caused by electric shock when not dealing with it correctly.
 Caution	Mark for caution This symbol denotes that there is a risk of slight injury or damage of device when not dealing with it correctly.
	Mark for prohibition This symbol denotes prohibition of the specified conduct. Description of the prohibition is displayed near the mark.

Caution items on equipment

	Be careful of a high voltage inside. A high voltage, which may risk your life, is used. This high voltage remains in the circuit after you have powered off switch. To prevent touching the high voltage circuit inadvertently, the hard cover is provided to the high voltage circuit and the high voltage caution label is affixed. Ensure to power off switch for your safety and discharge the electricity remaining in the capacity before starting to check. An engineer authorized by our company should inspect and maintain
 Warning	Be sure to power off in the boat. If the power switch is inadvertently powered on during work, you will be electrified. To prevent such accident from occurring, ensure to power off in the boat and the power of equipment. Furthermore, it is safer to hang the caution tag described as [Under Work] near the power switch of equipment.
 Warning	Be careful of dust Inhaling dust may cause A respiratory disease. When cleaning the inside of equipment, be careful not to inhale dust. Wearing a safety mask is recommended.

 Caution	Caution on location of equipment Do not install the equipment where it is excessively damp and suffers from excessive water drops.
 Caution	Measures against static electricity The static electricity may be generated from the carpet on the floor in the cabin or clothes made of synthetic fiber. The static electricity may destroy the electronic parts on the circuit board. Handle the circuit board, taking the measure of static electricity free.
 Caution	Caution at installation of a transducers Install the transducer at the location where it is not affected by bubble and noise. The bubble and noise seriously degrade the performance of this unit.

Caution Items on handling

 Warning	Do not disassemble or modify. It may lead to trouble, fire, smoking or electric shock. In case of trouble, contact our dealer or our company.
 Warning	In case of smoke or fire, boat power off and the power of this unit. It may cause fire, electric shock or damage.
	Be cautious of remaining high voltage. A high voltage may remain in the capacitor for several minutes after you have powered off. Before inspecting inside, wait at least 5 minutes after powering off or discharge the remaining electricity in an appropriate manner. Then, start the work.
 Caution	The information displayed in this unit is not provided directly for your navigation. For your navigation, be sure to see the specified material.
 Caution	Use the specified fuse. If un-specified fuse is used, it may cause a fire, smoke or damage.
 Caution	Whenever transmitting, be sure to submerge the transducer in water first. If transmitted without submerging the transducer, it may be damaged.

Contents

Document Revision History	i
Important Notice	ii
For Your Safe Operation	iii
Contents	v
System Configuration	vii
Configuration of Equipment	viii
Dimensions	xi
Specifications	xii
Chapter 1 Installation	1-1
1.1 Installation precautions	1-1
1.1.1 Unpacking of components	1-1
1.1.2 Appearance verification of each unit and accessories	1-1
1.1.3 Selection of location for installation	1-1
1.1.4 Laying and connection of cables	1-2
1.1.5 Coordination after installation	1-2
1.2 Installation of CVS-702D Display unit.....	1-3
1.2.1 Desk-top installation.....	1-3
1.2.2 Flush-mount installation	1-5
1.3 Installation of transducer.....	1-6
1.3.1 Transducer installation	1-6
1.3.2 Through-hull installation	1-6
1.3.3 Adjustments after installation	1-7
1.4 Wiring.....	1-8
1.4.1 Connection of cables to Display unit.....	1-8
1.5 Connection of Hemisphere V102 GPS Compass / ComNav Vector G1 GPS Satellite Compass	1-18
1.5.1 Connection of Hemisphere V102 GPS Compass / ComNav Vector G1 GPS Satellite Compass	1-18
1.5.2 Setting of Hemisphere V102 GPS Compass / ComNav Vector G1 GPS Satellite Compass	1-23
1.6 List of input/output sentences	1-29
1.6.1 Input sentence	1-29
1.6.2 Output sentence.....	1-29
Chapter 2 Adjustment	2-1
2.1 Setup of transducer.....	2-1
2.1.1 Setup of type of high frequency transducer	2-1
2.1.2 Setup of type of low frequency transducer	2-2
2.2 Setup of frequency of transducer.....	2-2
2.2.1 Setup of frequency for high frequency transducer.....	2
2.2.2 Setup of frequency for low frequency transducer	2-3
2.3 Setup of Beam Angle of transducer	2-3
2.3.1 Setup of Beam Angle for high frequency transducer	2-3
2.3.2 Setup of Beam Angle for low frequency transducer	2-4
2.4 Setup of Bottom Limit.....	2-4
2.4.1 Setup of Bottom Limit HF	2-4
2.4.2 Setup of Bottom Limit LF	2-5
2.5 Setup of Draft Set	2-5
2.6 Setup of Gain (TD) for transducer	2-5
2.7 Setup of Output Limit for transmitter.....	2-6
2.7.1 Display of Output Limit Menu.....	2-6
2.7.2 Setup of Output Limit HF	2-6
2.7.3 Setup of Output Limit LF	2-7

2.7.4 Relation of the set value between [Output Limit] and [MENU] - [Echo Adjust] - [TX Power] 2-7

Chapter 3 Maintenance 3-1

3.1 Inspection 3-1

3.2 Cleaning 3-1

3.2.1 Display unit 3-1

3.2.2 Transducer 3-2

3.3 Fuse Replacement 3-2

3.4 Diagnostics of troubles 3-2

3.4.1 Necessary information for requesting repair 3-2

3.4.2 Diagnostics 3-3

3.4.3 LCD Test 3-4

3.4.4 Initialize 3-4

3.4.5 Update of program 3-4

3.5 If you suspect a trouble 3-6

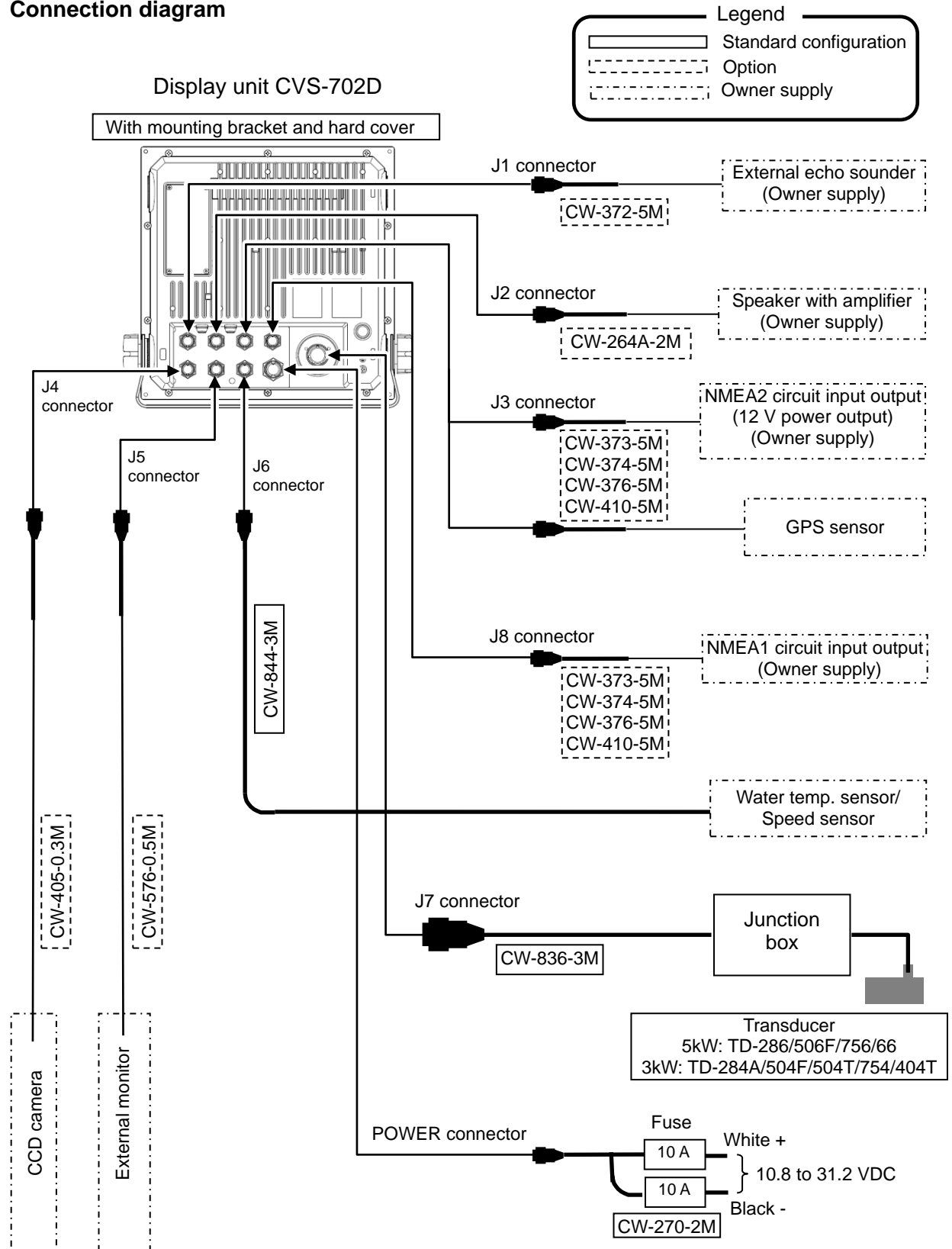

System Configuration

Connection diagram

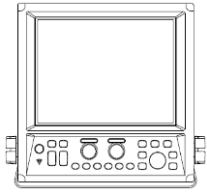
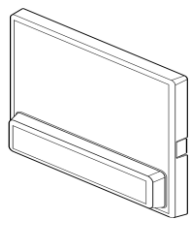
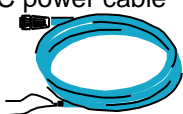
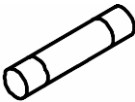

Configuration of Equipment

Standard Equipment Configuration List

No.	Name of item	Type	Remark	Weight/ Length	Qty
1	Display unit 	CVS-702D	With mounting bracket and knobs	9.1 kg	1
2	Hard cover 	A30MB10250		390g	1
3	DC power cable 	CW-270-2M	With 5pin connector and one end plain	2 m	1
4	Fuse 	F-7161-10A/ N30C-125 V type(φ6.4 × 30)	Normal fusion type for main power		2
5	Junction Box	JB-34	Junction box for Transducer/ water temperature sensor/ speed sensor		1
6	Connector 	BD-06BFFA- LL6001	6pin water resistant connector		2
7	Transducer	Refer to next page "Type of transducer"	Transducer cable		1
8	Basic Operation Manual	CVS-702D.BM.E	English		1
9	Full Menu Reference	CVS-702D.FM.E	English		1
10	Quick Reference	CVS-702D/705D/707D .QR.E	English		1
11	Installation manual	CVS-702D.IM.E	English		1
12	Menu List	CVS-702D/705D/707D .ML.E	English		1
13	Cable for transducer	CW-836-3M	With 5pin connector and one end soldering to insert to JB	3 m	1
14	Cable for water temp. sensor/speed sensor	CW-844-3M	For connection of water temp. and speed sensors	3 m	1
15	Resonance capacitor	0.022μF, 0.1μF	For ferrite transducer		1 set

Type of transducer

No.	Specification	Frequency output	Material/ Cable length/ Cable diameter	Mounting method	Beam width (- 6 dB) (Right and left x Back and forth)(-6 dB)
1	TD-286	28kHz 5kW	Rubber mold 20 m φ11	Ship's bottom/ Ship's side	23° x 23°
2	TD-506F	50kHz 5kW	Rubber mold 20 m φ11	Ship's bottom/ Ship's side	14° x 14°
3	TD-756	75kHz 5kW	Rubber mold 20 m φ11	Ship's bottom/ Ship's side	10° x 9°
4	TD-66	200kHz 1kW	Urethane mold 20 m φ11	Ship's bottom/ Ship's side	6° x 6°
5	TD-284A	28kHz 3kW	Rubber mold 10 m φ11	Ship's bottom/ Ship's side	30° x 18°
6	TD-404T	40kHz 3kW	Rubber mold 10 m φ11	Ship's bottom/ Ship's side	16° x 11°
7	TD-504T	50kHz 3kW	Rubber mold 10 m φ11	Ship's bottom/ Ship's side	14° x 9°
8	TD-504F	50kHz 3kW	Rubber mold 10 m φ11	Ship's bottom/ Ship's side	14° x 11°
9	TD-754	75kHz 3kW	Rubber mold 10 m φ11	Ship's bottom/ Ship's side	14° x 7°

Please consult a dealer of Koden or Koden about another type of transducer.

Option List

No.	Name of Item	Specification	Remark	Weight/ Length
1	Power rectifier	PS-010	Fuse (5A) 2 pcs.	
2	AC power cable	VV-2D8-3M	Both ends plain.	3 m
3	Transducer extension cable	CABLE_VSV-2T11-White.Black		Specify length at order
4	Grounding cable	OW7/1.6S-3M		3 m
5	Connecting cable	CW-372-5M	With a 5 pin water resistant connector & one end plain	5 m
		CW-373-5M	With 6 pin water resistant connectors both ends	5 m
		CW-374-5M	With a 6 pin connector & a 6pin water resistant connector	5 m
		CW-376-5M	With a 6 pin water resistant connector & one end plain	5 m
		CW-410-5M	With 6 pin water resistant connectors both ends (Both 1-pin (shield) are not wired)	5m
		CW-560-2M	With 15 pin water resistant D-Sub connectors both ends	2 m
		CW-264A-2M	12 pin waterproof connector at one end / ϕ 3.5 stereo jack at one end	2 m
		CW-405-0.3M	Junction cable for CCD camera	0.3 m
6	Cable for external monitor	CW-576-0.5M	Junction cable for external monitor With a 10 pin water resistant connector & a D-Sub connector	0.5 m
7	Connector	BD-05BFFA- LL6001	5 pin water resistant connector	
		BD-06BFFA- LL6001	6 pin water resistant connector	
8	Transmission filter	Transmission C29EHB004A	Filter against leakage from wireless equipment	

Dimensions

Weight : 9.1kg(20.1lb) [inclusive base/架台含む]
重量

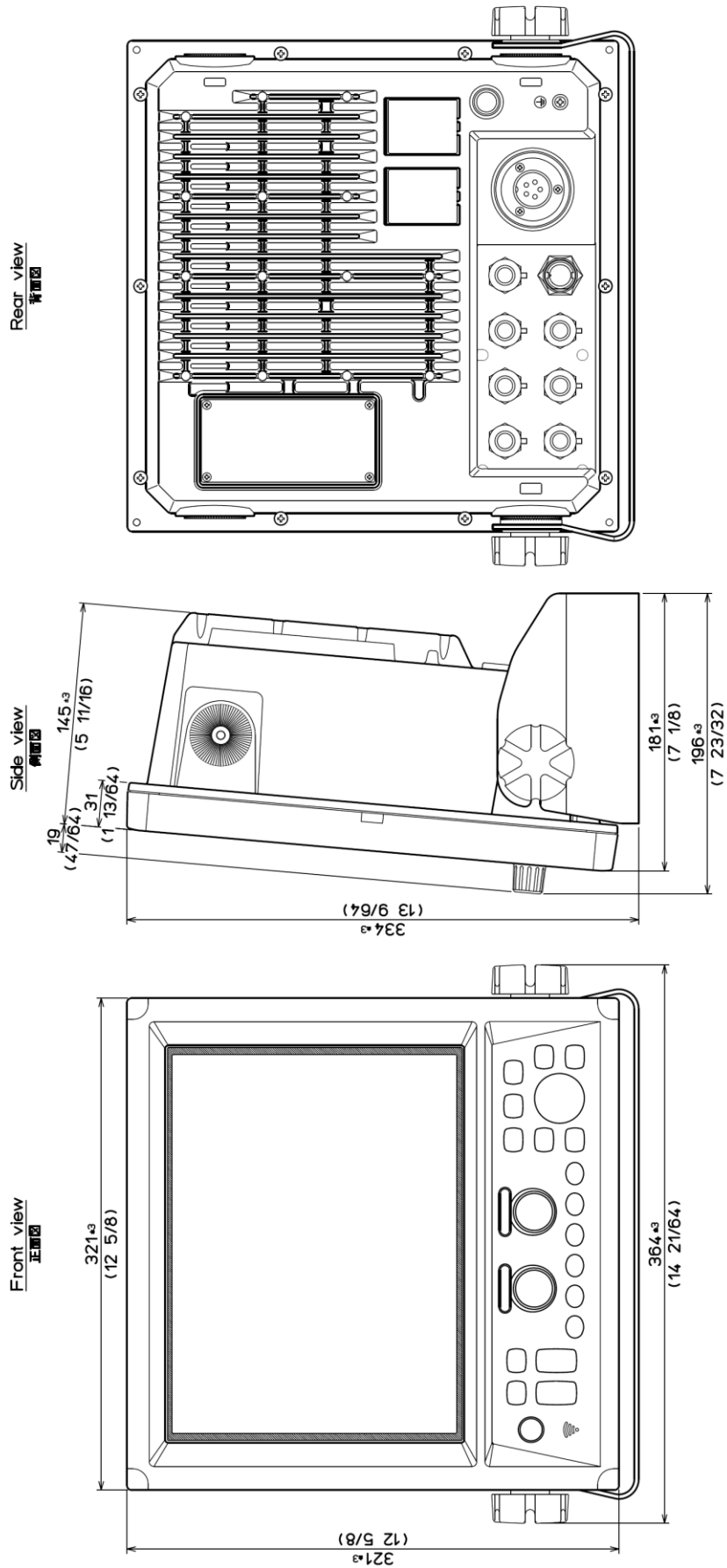

Unit: mm (inch)

Specifications

Item	Content
Model	CVS-702D
Output power	5kW
Output frequency (Transducer)	Dual Freq : 28,50,75,200 kHz (200 kHz is 1 kw only)
Output method	Single, 2 frequency, Simultaneous
TX rate	1500 pulses / minute at maximum (In case of single frequency, Range 2.5m and Interference rejection off)
Pulse width	50 μ s to 3.0 ms
Display size and type	12.1 -inch color XGA LCD
Display resolution	1024 x 768 pixels (XGA)
Basic range	1 to 3000 (m), 5 to 8000 (ft), 1 to 1700 (fm), 1 to 2000 (l. fm) (8 ranges can be set to users choice)
Zoom range	1 to 260 (m), 5 to 960 (ft), 1 to 140 (fm), 1 to 180 (l. fm)
Range unit	m, ft, fm, l.fm
Shift	Max 3000 (m), 6000 (ft), 1100 (fm / l. fm)
Shift step	Selectable: Numerical value, Range ratio 1/5, Registered value (8 type), Shift digit input, Range dependent
Presentation modes	High frequency, Low frequency, 1 to 2 frequency, Zoom image (Bottom lock, Bottom discrimination, Bottom zoom, Zoom, Bottom follow zoom), Nav mode, Vertical split, Horizontal split, Mix A-scope can be displayed at all above modes
Presentation colors	64 colors, 16 colors, 8 colors, Monochrome
Back ground colors	Marine blue, Blue, Dark blue, Black, White, Night color, Other 4 colors
Alarms	Bottom, Fish, Temperature*, Speed**, Arrival***, XTE***
Image speed	12 steps & stop
Functions	Interference rejection, Color rejection, VRM, Noise reduction, White line, Draft correct, Water temperature correct, Boat speed correct, Store image (500 images), Sona-Tone™, Homing, Event memory, Simple plotter, Panel illumination, Power reduction, External trigger, Detection area display, CM key, Water Temp. graph, Individual range operation, Individual shift operation, Heaving compensation
Auto functions	Range, Shift, TVG, TX Power, White Line
Function key registration	A scope, Shift digit input, Interference rejection, Color rejection, Noise reduction, White line, Background color, TVG adjust, VRM interval, Image recall, Image swap, Image title, Sona-Tone™, Nav start, Frequency, Event key usage, Key lock, Depth unit, Color tone, Bottom discrimination mode
Language	Traditional Chinese, Simplified Chinese, English, French, Greek, Italian, Japanese, Korean, Spanish, Thai, Danish
Input data format and sentences	NMEA0183 Ver.1.5 / 2.0 / 3.0 GGA, GLL, HDT, MTW, MWV, MWD, RMC, VHW, VTG, ZDA
Output data format and sentences	NMEA0183 Ver.2.0 (DBT : Ver.1.5) DBT, DPT, GGA, GLL, HDT, MTW, MWV, RMC, TLL, VHW, VTG, ZDA
NMEA ports	Total 2: input and output
Power supply	10.8 to 31.2 VDC
Power consumption	60 W or less (24 VDC)
Environmental	
Operating temperature	- 15 °C to + 55 °C
Water protection	IPX5
Store temperature	- 30 °C to + 70 °C
Upper limit of humidity	93 % \pm 3 % (At + 40 °C)
Dimension of equipment (without knobs & pedestal)	Display unit: 321 x 321 x 145 mm
Dimension of equipment (with knobs & pedestal)	Display unit: 334 x 364 x 181 mm
Weight	Display unit: 9.1 kg

* Requires data from Temp sensor

** Requires speed data from Speed sensor or GPS sensor

*** Requires data from GPS sensor

Chapter 1 Installation

1.1 Installation precautions

In order to obtain the maximum performance of the echo sounder, this echo sounder should be installed by a qualified engineer in charge of installation and maintenance. Installation procedures include the following:

- (1) Unpacking of components
- (2) Inspection of composition units, spare parts, accessories and installation materials.
- (3) Checking of supply voltage and current capacity
- (4) Selection of location for installation
- (5) Installation of CVS-702D Display unit and transducer
- (6) Attachment of accessories
- (7) Planning and implementation of cable laying and connection
- (8) Coordination after installation

1.1.1 Unpacking of components

Unpack components and check that all the items correspond with the description of the packing list. When a discrepancy or damage has been found, contact the dealer you purchased or our sales company.

1.1.2 Appearance verification of each unit and accessories

Inspect the appearance of each components and accessories and check that no dents or damages exist.

If any dents or damages exist and they are believed to be caused by accident during transportation, contact the transportation and insurance company and consult our sales company or our dealer nearest to you.

1.1.3 Selection of location for installation

In order to obtain the maximum performance of the unit, it is necessary to install in consideration of matters described below:

- (1) Install the equipment at a location in a bridge so that its display can be easily seen.
- (2) Keep enough space for maintenance. Especially, secure enough space at the rear panel where many cables are connected.
- (3) Keep the equipment as far away from wireless transmitter/receivers as possible.

1.1.4 Laying and connection of cables

- (1) Keep the transducer and power cable as far away from the cables of other electronic equipment as possible.
- (2) The cabinet of CVS-702D Display unit shall be securely grounded to the hull, using the grounding terminal on the rear panel.

⚠ Caution: The ground side of power input of this equipment is connected to the ground terminal.
In case of + (positive) ground, it cannot be used. The power may short-circuit.

- (3) If you connect the power cable directly to the battery, interference from the other electronic equipment is expected to be less. (See Fig. 1.1)

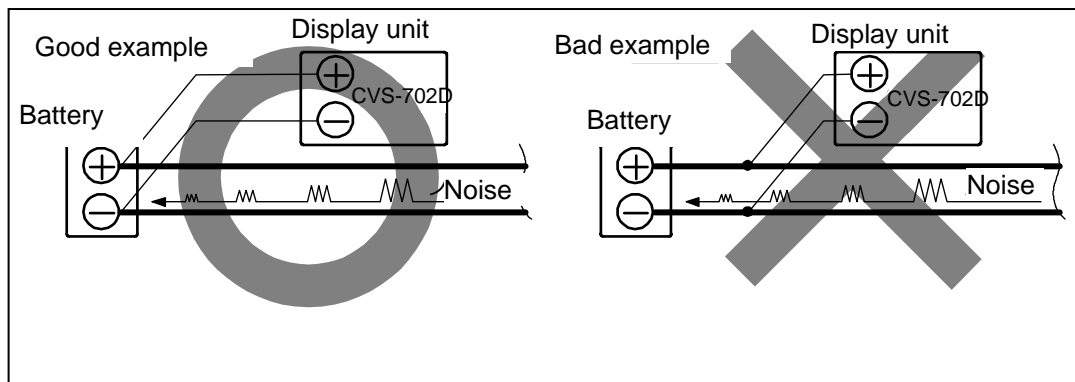

Fig. 1.1 Connection of Power line

1.1.5 Coordination after installation

Be sure to confirm the following points before starting up this equipment. The confirmation is mandatory to operate the equipment normally:

- (1) Is the power voltage in the boat within the appropriate voltage range? Is the current capacity enough?
(Voltage range: 10.8 VDC to 31.2 VDC measured at the power connector.)
- (2) Is the electric current capacity sufficient?
(Power consumption: 60 W)
- (3) Is the wiring of transducer cable correct? Is the wiring shorted?

1.2 Installation of CVS-702D Display unit

CVS-702D Display unit can be installed either on desk-top or flush-mounted.

Install in the following procedure.

1.2.1 Desk-top installation

- (1) Decide the location to install the Display unit and keep the space for the maintenance works as shown in Fig. 1.3.
- (2) Place the bracket on the position where the Display unit will be installed and fix the bracket with five 5 mm screws.
- (3) Place the Display unit on the installation bracket and fix the Display unit with washers and knob bolts.

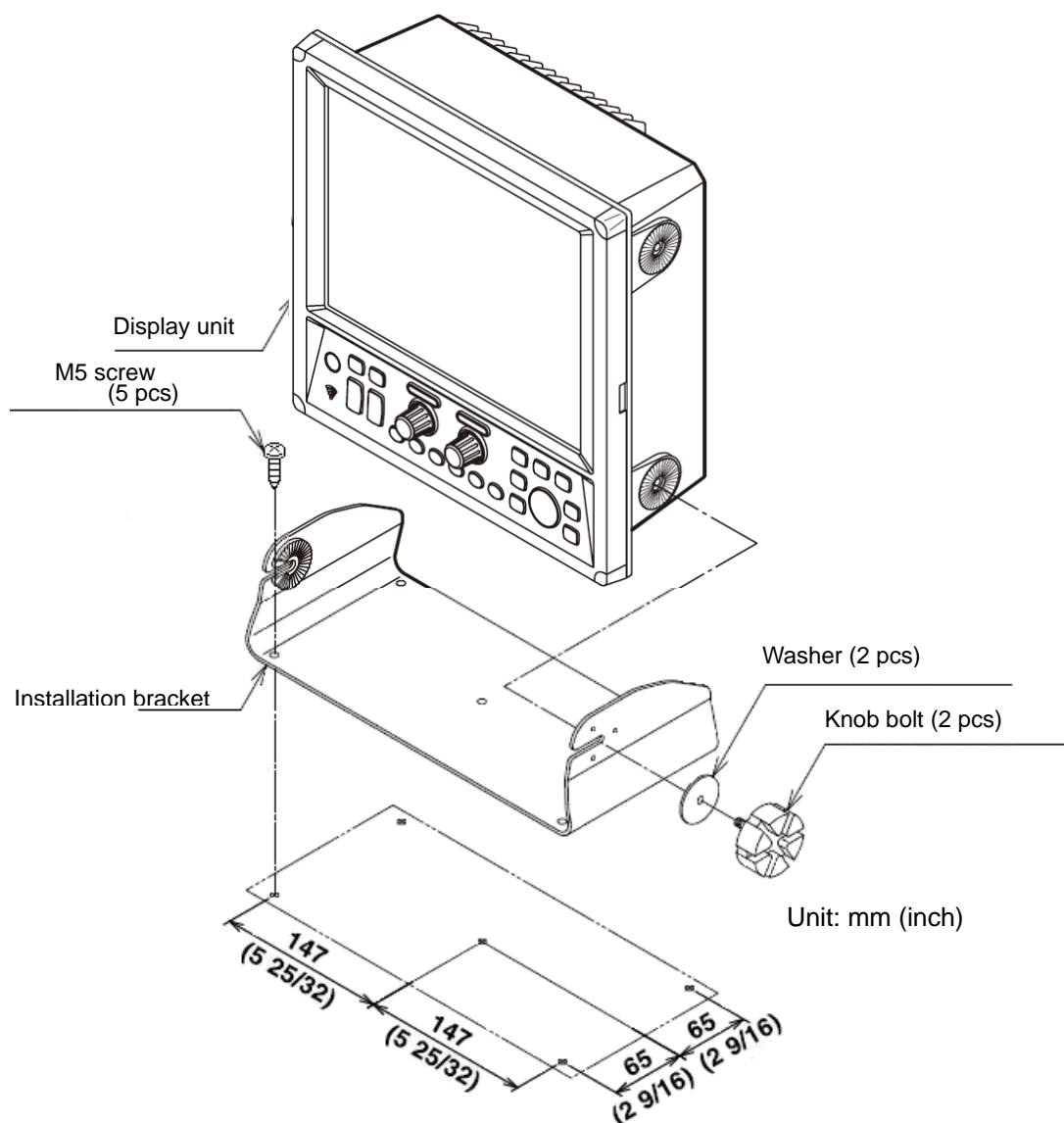
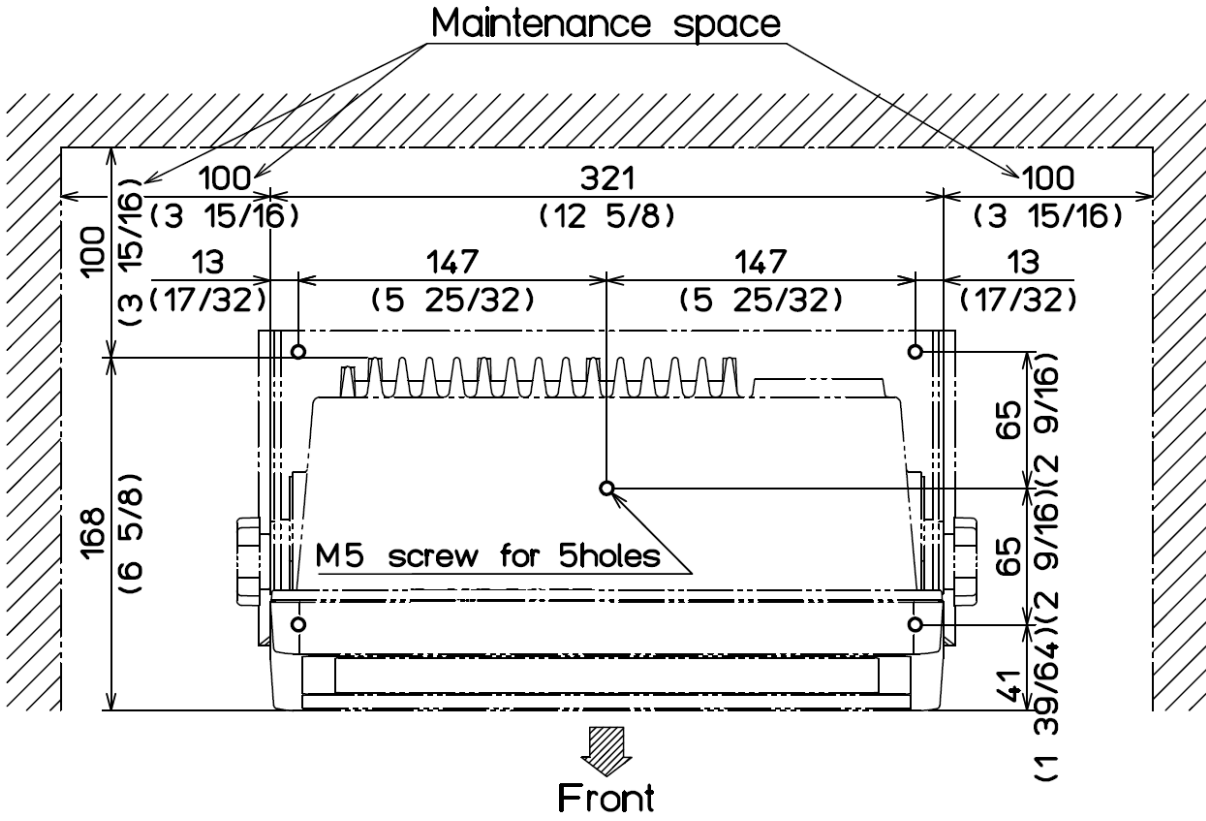

Fig. 1.2 Desk-top installation

! Caution: At installing on desktop, keep the maintenance space is required as shown below.



Unit: mm (inch)

Fig. 1.3 Maintenance space

1.2.2 Flush-mount installation

- (1) Make a square hole at the location to be installed (See Fig. 1.5)
- (2) Remove four plastic corner caps of the Display unit (These can be easily pulled out upwards).
- (3) Confirm that the unit matches the square holes. If not matched, correct the square hole.
- (4) Connect the connectors for power and transducer to the unit respectively.
- (5) Install the Display unit in the installing location (square hole) and fix it with four tapping screws (4mm) (M4 or pan-head). (Prepare 4 mm screws suitable for thickness of installing location.)
- (6) Install the corner caps removed in step (2).

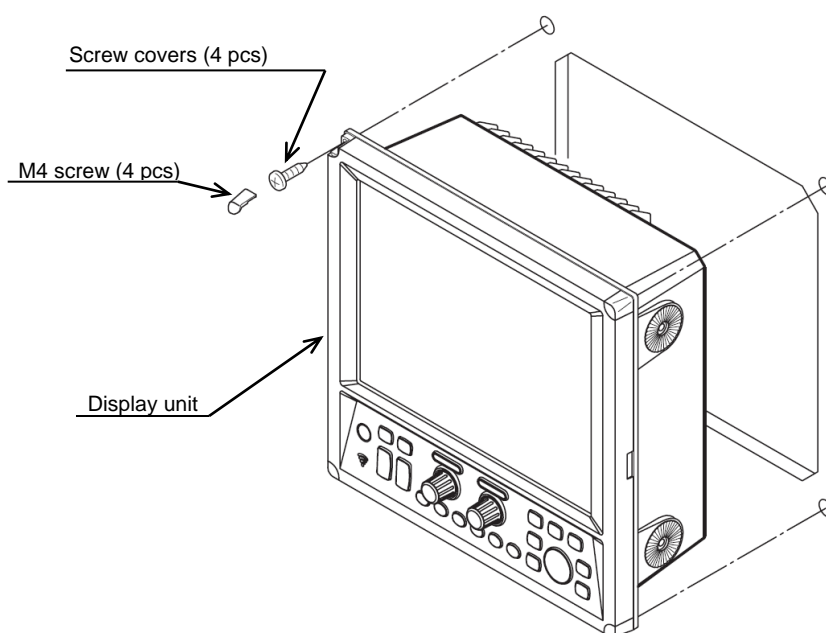
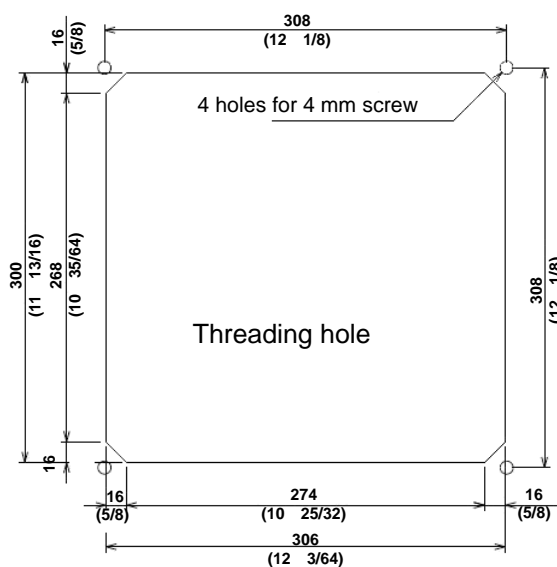

Fig. 1.4 Flush-mount installation



Unit: mm (inch)

Fig. 1.5 Hole for flush-mount installation of Display unit

1.3 Installation of transducer

1.3.1 Transducer installation

The transducer should be installed in a location free of bubbles and away from disturbed water flow. Smooth water flow around the transducer and along its surface are very important for consistent operation. Areas in the center of water line length at cruising speed are usually satisfactory. Forward of the engine and in a flat area near the center line of the boat are preferred. Do not install the transducer behind water intakes, other through-hull fittings or irregularities in the hull.

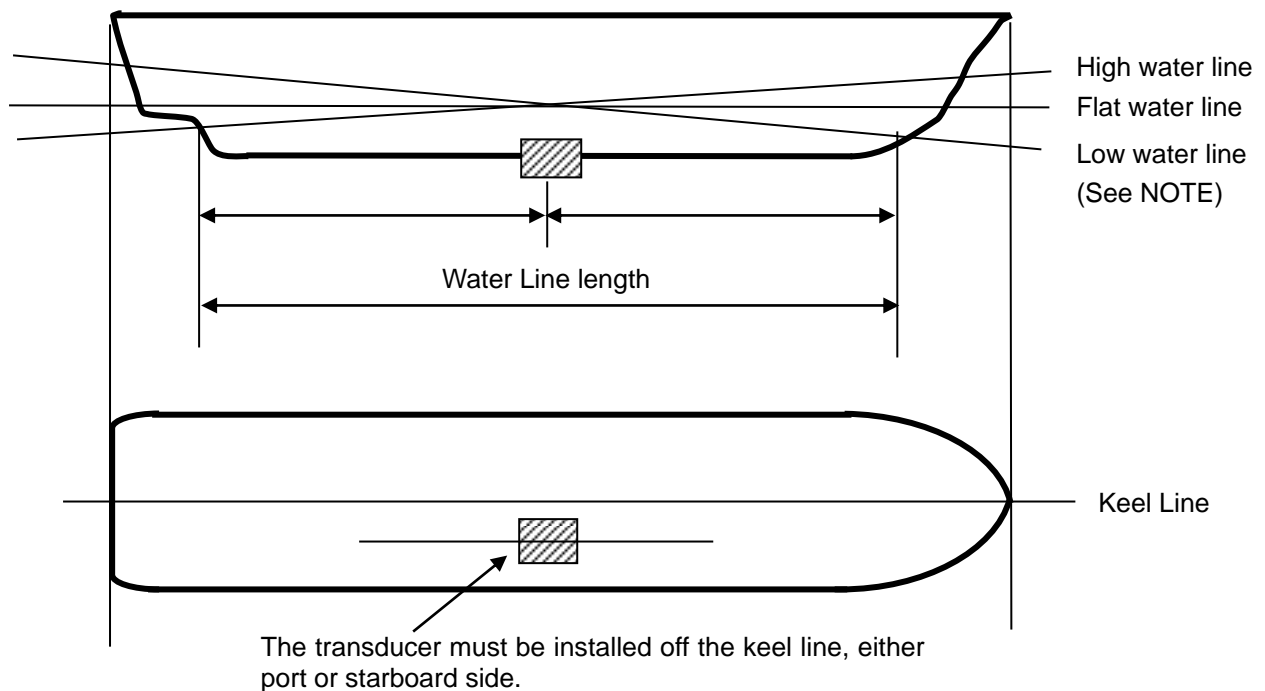

NOTE:

High water line: Water line when vessel pitches up most.

Low water line: Water line when vessel pitches down most.

Figure 1.6 Recommended area of transducer installation

1.3.2 Through-hull installation

Transducer installation for CVS-702D is only possible with through-hull installation. Various types of rectifying tanks (Turbulence Minimizing Enclosure) are prepared according to the material of the ship's hull or transducer frequency used. Mount the rectifying tank to the ship's bottom before mounting the transducer to in the rectifying tank. The more the tank protrudes, the less the water turbulence.

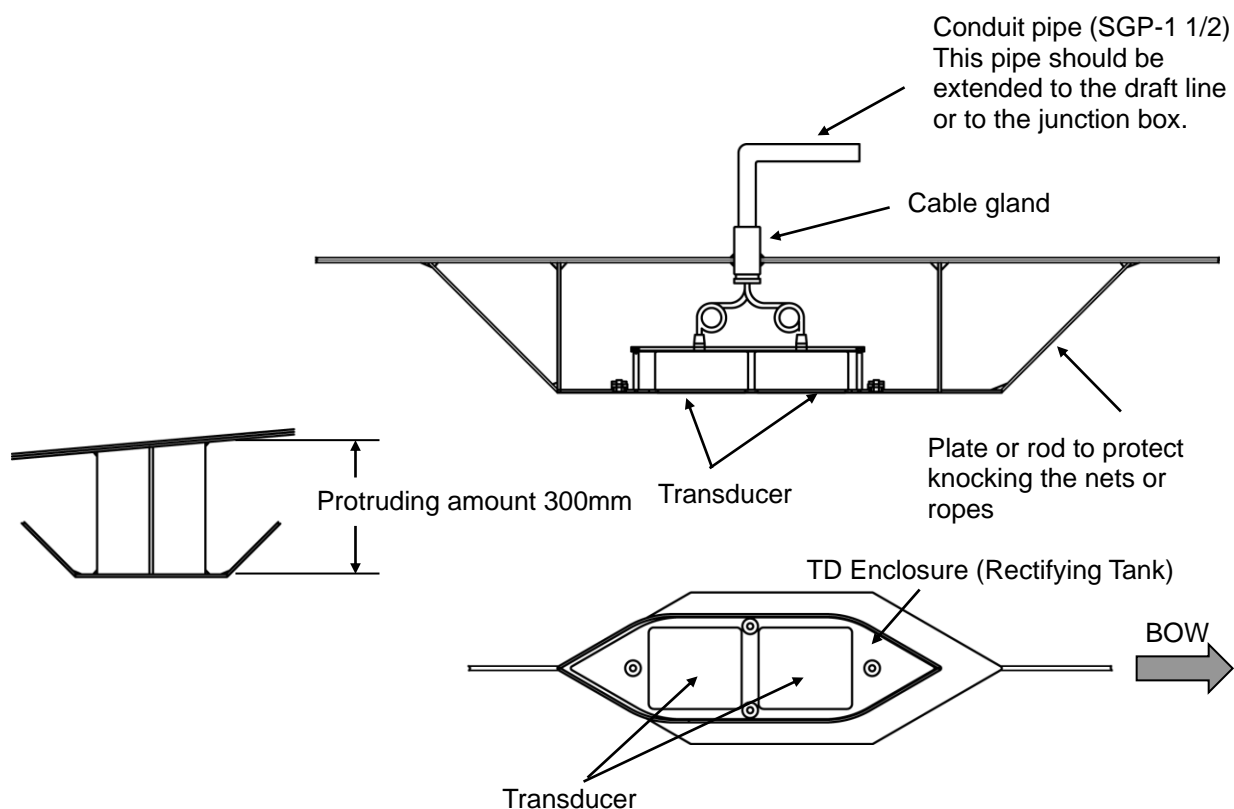

Figure 1.7 An example of through-hull transducer installation

1.3.3 Adjustments after installation

Before you turn the unit on, check the following points to make sure the CVS-702D operates properly.

- (1) Is the ship's supply voltage and current within the rated range?
- (2) Is the transducer wiring normal? No wrong connections, no short circuits, etc.?
- (3) Are the High and Low frequency transducers properly connected to their mating terminals?
- (4) Are the cables routed and connected properly?

1.4 Wiring

1.4.1 Connection of cables to Display unit

Connect the power cable and cables from the transducer to the connectors on the Display unit.

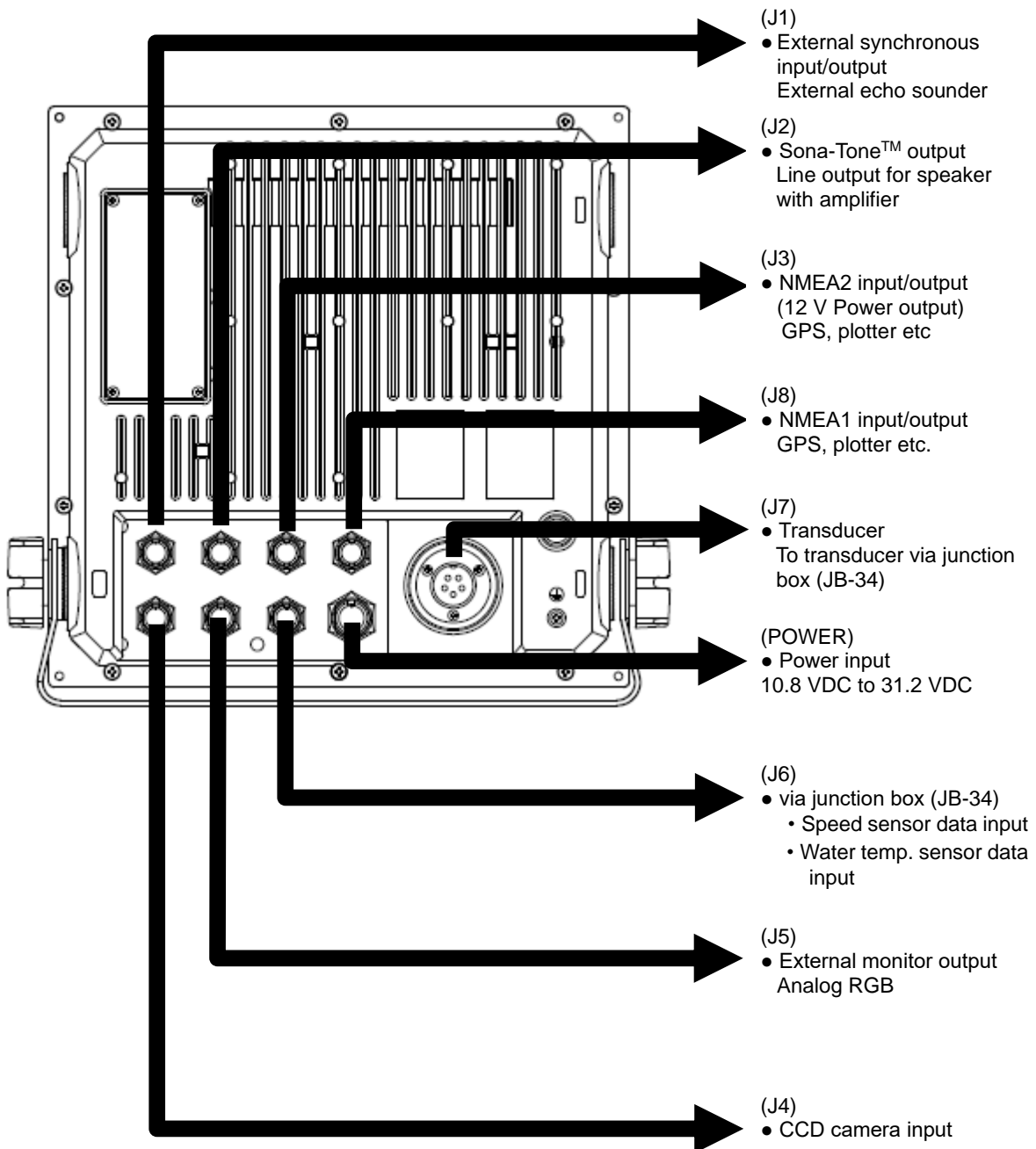

Fig. 1.8 Cable connections

Pin assignment of rear connectors

Pin assignment viewed from the rear of Display unit:

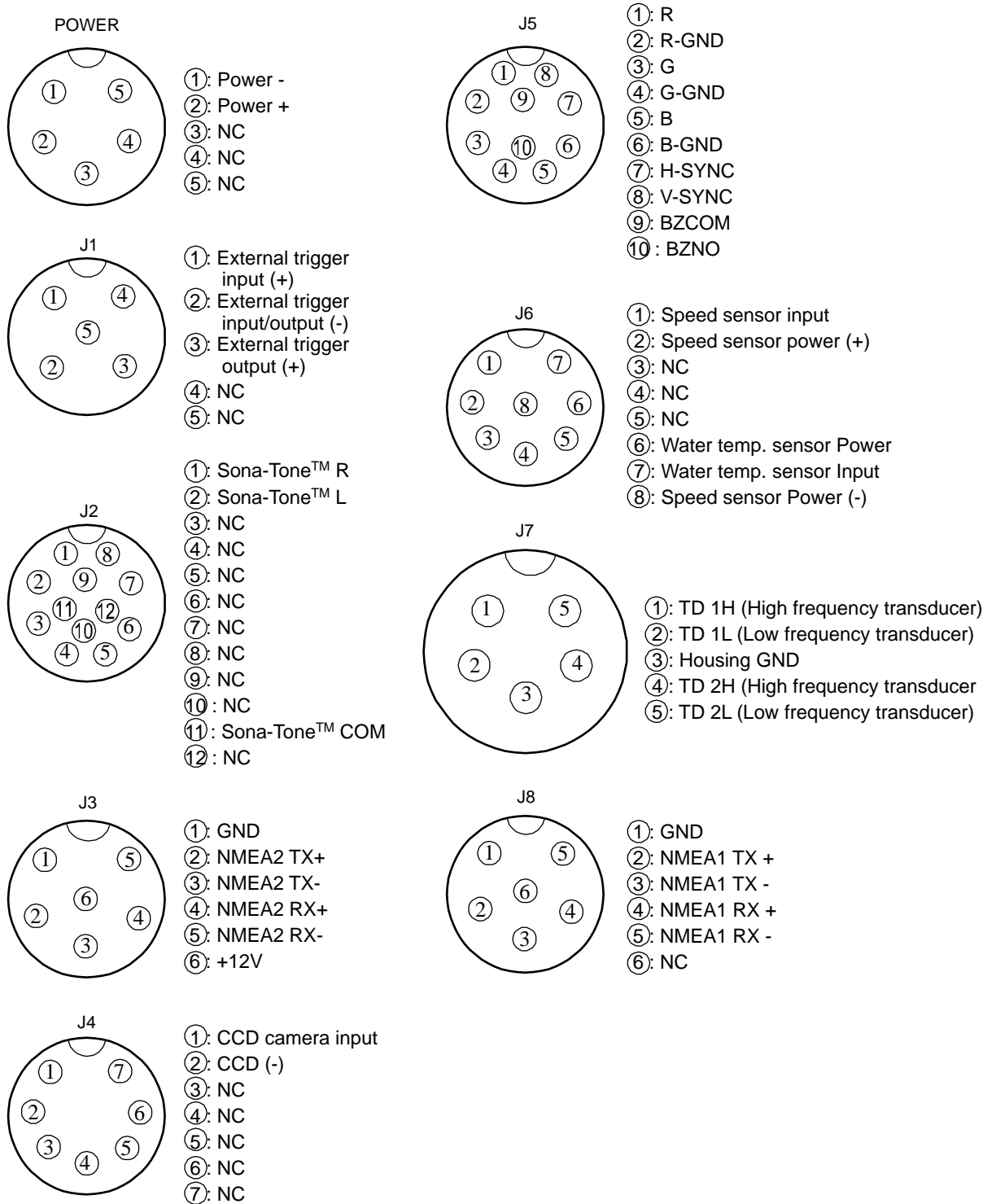

Fig. 1.9 Pins assignment of rear connector

 **Caution: Do not connect each wire to ship's earth.**

Connection of power cable (CW-270-2M)

Connect the power cable to the [POWER] connector at the rear of the Display unit.

Connection of DC power cable (CW-270-2M)

Fig. 1.10 Connection of DC power cable

⚠ Caution: Wind the insulation tape around the un-used lead wire for core-wires not to contact each other.

⚠ Caution: Confirm the main switch-board off before connecting power cable.

Connection of transducer

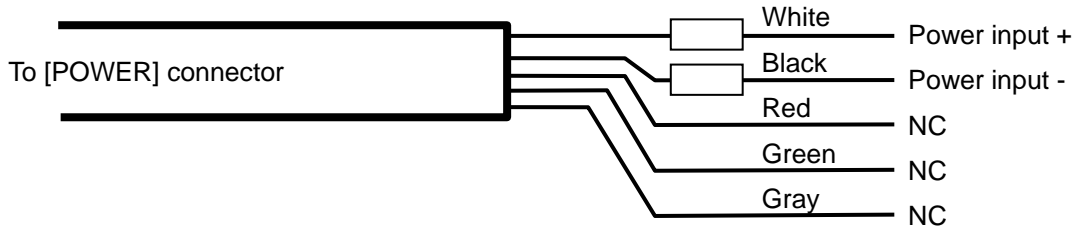
In the case of connection of CVS-702D and transducer:

- 1) Referring to the connection table of transducers, solder CW-836-3M and CW844-3M to the transducer. After soldering is completed, be sure to provide the connected part with water resistance and insulation using self adhesive tape, etc.
- 2) Connect CW-836-3M after the above processing to J7 connector of CVS-702D.
Connect CW-844-3M after the above processing to J6 connector of CVS-702D.

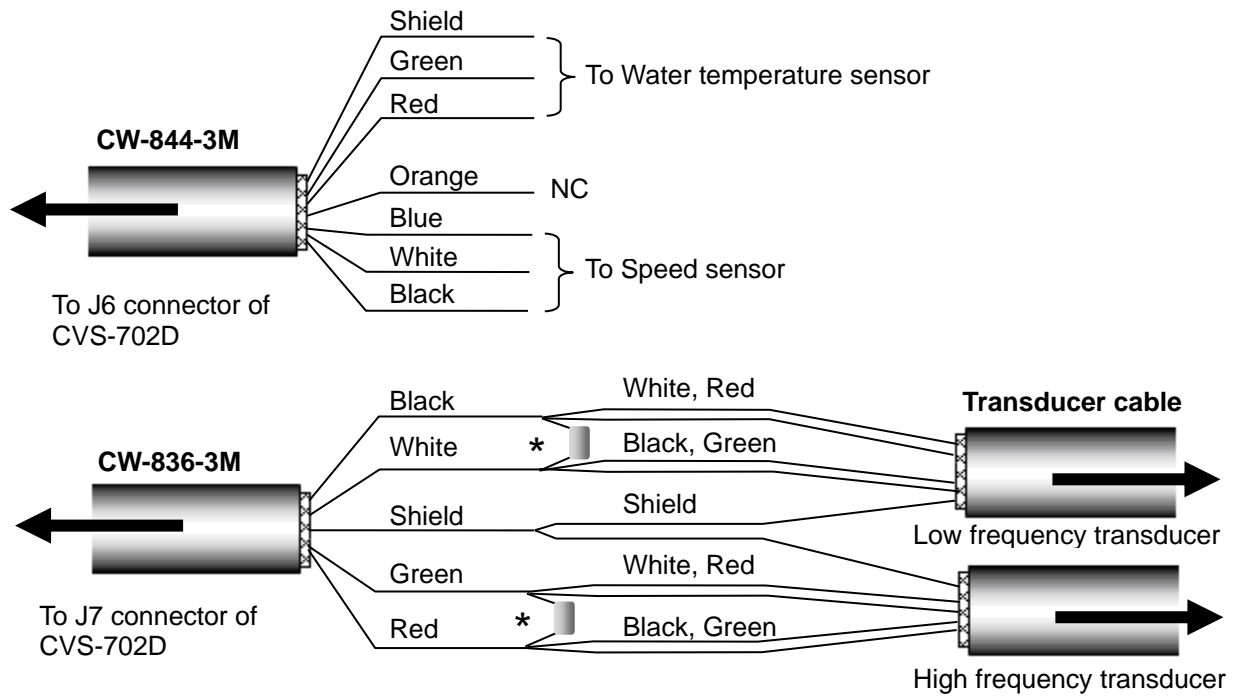

*The ferrite transducer should be connected to the resonance capacitor.

Fig. 1.11 Connection of transducer cable

Connection table of Water temp. sensor/Speed sensor

J6		Connecting cable CW-844-3M	Note
No.	Signal name	Wire color	
4	Shield	Shield	For Water temp. sensor
6	Water temp. sensor power	Green	
7	Water temp. sensor input	Red	
3	NC	Orange	NC
1	Speed sensor input	Blue	For Speed sensor
2	Speed sensor power (+)	White	
8	Speed sensor power (-)	Black	

Connection table of transducer

J7		Connecting cable CW-836-3M		Note
No.	Signal name	Wire color	Signal name	
5	TD2L (Low frequency transducer)	Black	TD2L	Low frequency
2	TD1L (Low frequency transducer)	White	TD1L	
3	Shield	Shield	Housing GND	Common GND
4	TD2H (High frequency transducer)	Green	TD2H	High frequency
1	TD1H (High frequency transducer)	Red	TD1H	

The ferrite transducer should be connected to the resonance capacitor.

Transducer	Capacitance value
TD-286	0.1 μ F and 0.022 μ F (Parallel connection)
TD-506F	0.1 μ F
TD-284A	0.1 μ F
TD-504F	0.047 μ F

 **Caution: Please consult a dealer of Koden or Koden about another type of transducer.**

In the case of connection via the junction box (JB-34):

- 1) Connect CW-836-3M to the junction box (JB-34).
- 2) Connect CW-836-3M to J7 connector of CVS-702D.

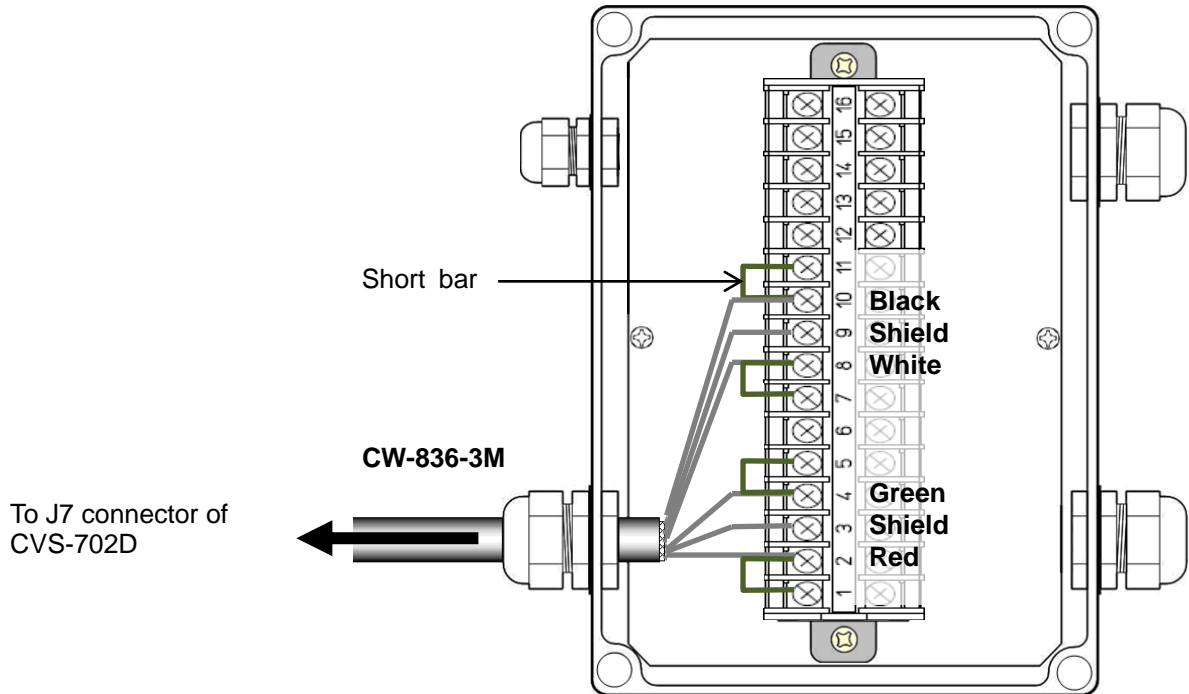

Fig. 1.12 Connection between CVS-702D and junction box

Connection list of junction box (JB-34)

CVS-702D		Connecting cable CW-836-3M	Junction box (JB-34)	
Pin No.		Wire color	Pin No.	Signal name
J7	1	Red	1	TD1H(High frequency transducer)
			2	
	3	Shield	3	GND
	4	Green	4	TD2H(High frequency transducer)
			5	
			6	-
	2	White	7	TD1L(Low frequency transducer)
			8	
3	Shield	9	GND	
5	Black	10	TD2L(Low frequency transducer)	
		11		
			12	
			13	
			14	
			15	
			16	

3) Connect the transducer and the junction box (JB-34).

- In case of TD-286* and TD-506F*

Cable of the transducer is configured as shown in Fig. 1.13.

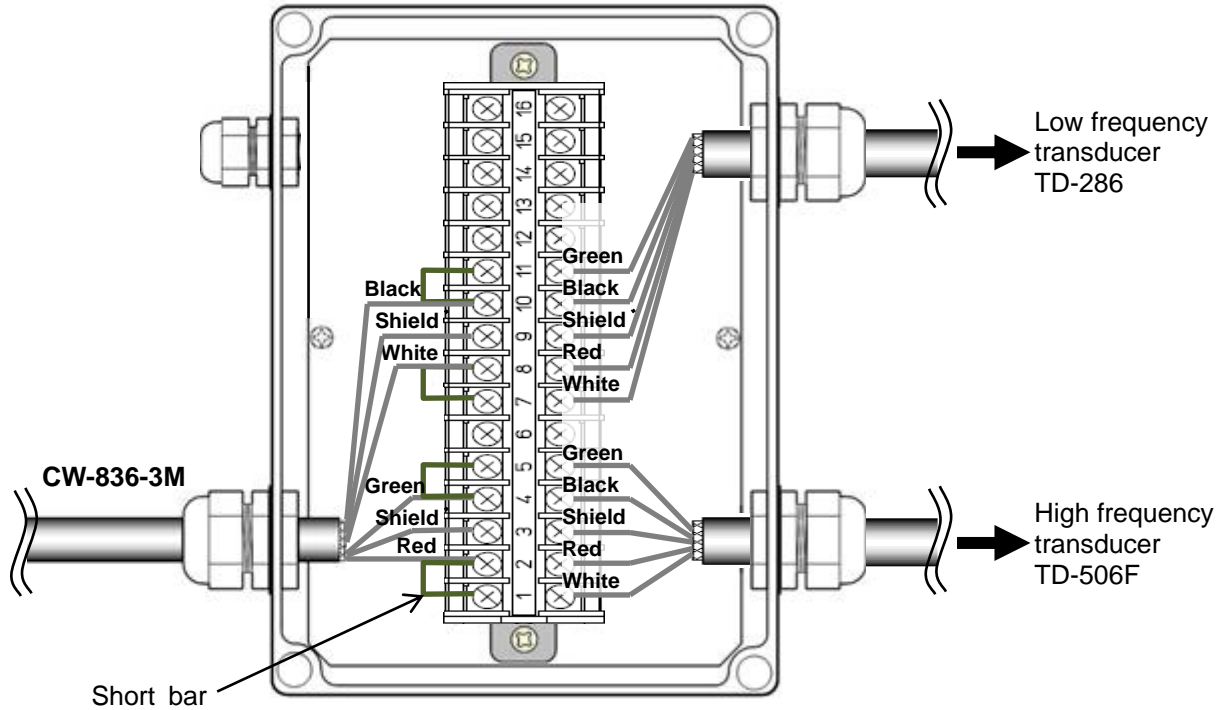

Fig. 1.13 Details of transducer cable

* The ferrite transducer should be connected to the resonance capacitor.

Transducer	Capacitance value
TD-286	0.1 μ F and 0.022 μ F (Parallel connection)
TD-506F	0.1 μ F

Connection of the resonance capacitor (Be sure transducer cable is connected to avoid damaging the system with capacitor only.)

- TD-286 (Connect to the Low frequency side.)

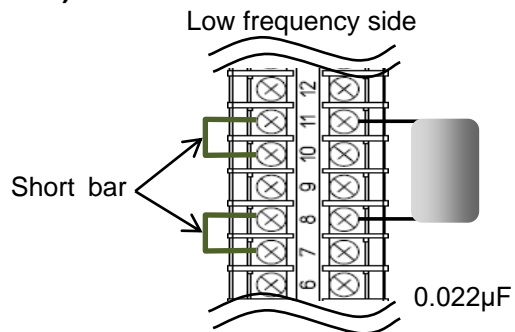
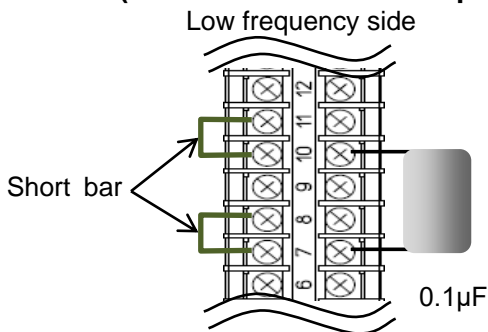

- TD-506F (Connect to the High frequency side when TD-286 is connected.)

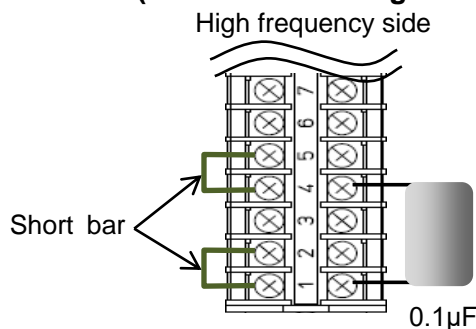

⚠ Caution: Do not transmit with capacitor only as internal circuit may be damaged.

- In case of TD-506F* and TD-66
Cable of the transducer is configured as shown in Fig. 1.14

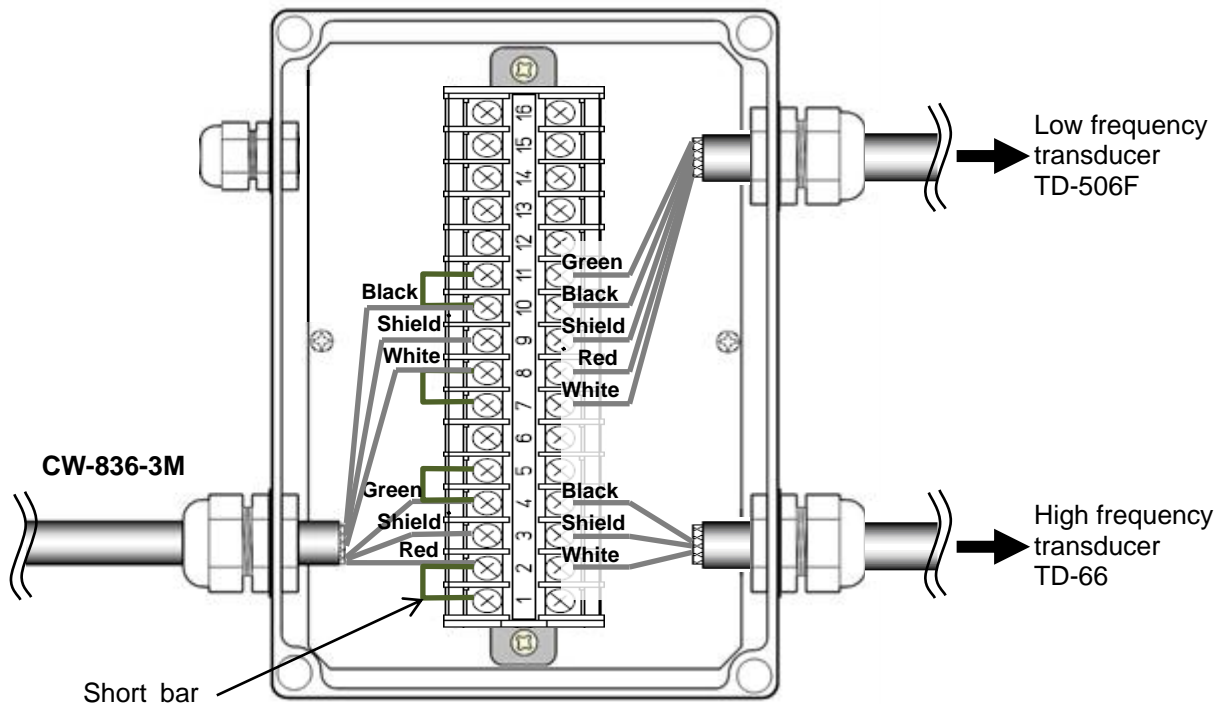

Fig. 1.14 Details of transducer cable

*The ferrite transducer should be connected to the resonance capacitor.

Transducer	Capacitance value
TD-506F	0.1 μ F

Connection of the resonance capacitor (Be sure transducer cable is connected to avoid damaging the system with capacitor only.)

- TD-506F (Connect to the Low frequency side when TD-66 is connected.)

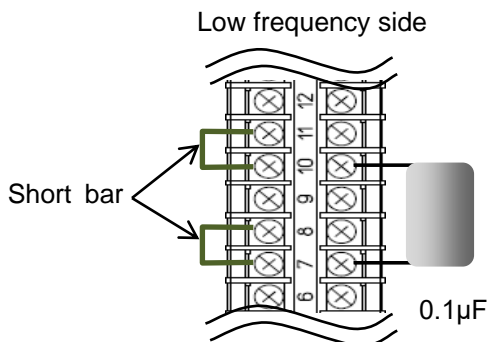

⚠ Caution: Do not transmit with capacitor only as internal circuit may be damaged.

Connection to external echo sounder

It is likely to observe mutual interference when the transmit frequency of an external echo sounder and CVS-702D is the same or close. Interference can be decreased by synchronizing the CVS-702D transmission with the trigger of the external echo sounder. Refer to the following for the connection.

Connector	Pin	Remarks
J1	①	External trigger input (+)
	②	External Trigger input/output(-)
	③	External Trigger output (+)
	④	NC
	⑤	NC

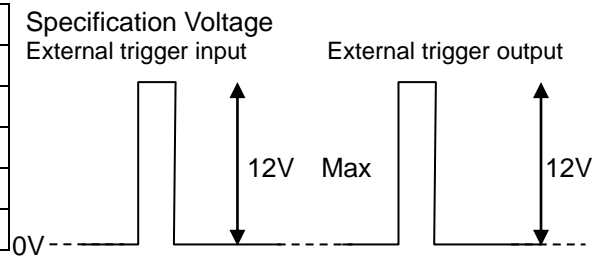

Fig. 1.15 External trigger

Connection with navigation equipment (J3, J8)

The NMEA data can be output from CVS-702D to an external navigation equipment, and the NMEA data can be input from an external navigation equipment to CVS-702D. Refer to the following for the connection.

Connector	Pin	Remarks
J3	①	GND
	②	NMEA TX +
	③	NMEA TX -
	④	NMEA RX +
	⑤	NMEA RX -
	⑥	+12V

Connector	Pin	Remarks
J8	①	GND
	②	NMEA TX +
	③	NMEA TX -
	④	NMEA RX +
	⑤	NMEA RX -
	⑥	NC

Connection of External Speaker for Sona-Tone™ (J2) [Owner supply]

The ø3.5 stereo jack is provided to the CW-264A-2M cable.

If you connect the speaker with the amplifier to the external, you can clearly hear the Sona-Tone™ sound.

Adjust the volume of speaker with the amplifier equipped to the speaker.

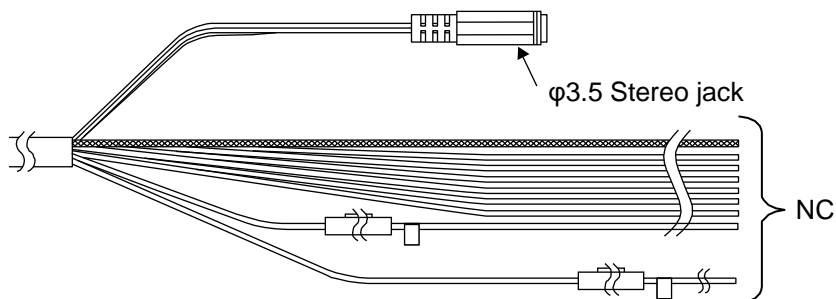

Fig. 1.16 Connection of External Speaker for Sona-Tone™

Connection of External Monitor (J5) [Owner supply]

When installing an external monitor (VGA monitor, analog RGB input), connect it via CW-576-0.5M. For its wiring, refer to the illustration below. After soldering, perform the waterproof and insulation treatment on the junction with a self-fusion tape.

Structure of CW-576-0.5M

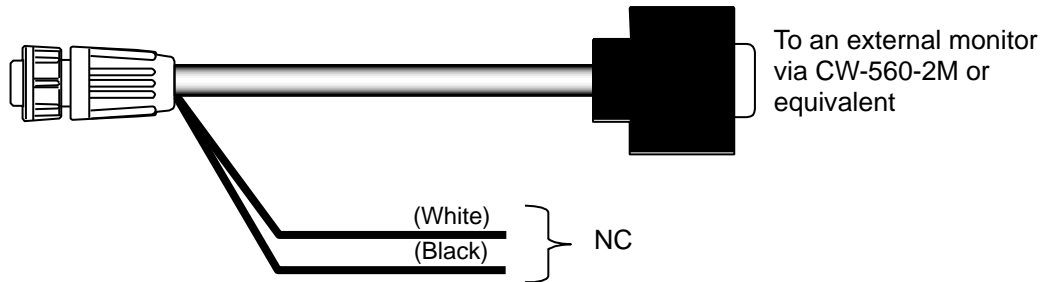

Fig. 1.17 Connection of External Monitor

Connection of CCD camera (J4) [Owner supply]

CVS-702D and a CCD camera (NTSC/PAL/SECAM) can be connected via CW-405-0.3M (option). Connect the video output terminal (RCA plug (In most cases, yellow)) of your CCD camera. Perform the waterproof treatment on the junction of the RCA terminal with a self-fusion tape. Refer to the following for the connection.

Connector	Pin	Remarks
J4	①	CCD camera input
	②	CCD (-)
	③	NC
	④	NC
	⑤	NC
	⑥	NC
	⑦	NC

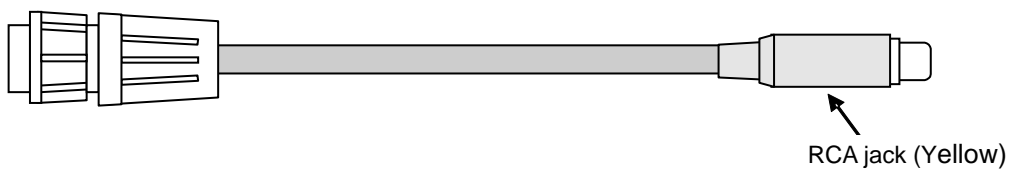

Fig. 1.18 Connection of CCD camera

1.5 Connection of Hemisphere V102 GPS Compass / ComNav Vector G1 GPS Satellite Compass

This is to describe the connection of Hemisphere V102 GPS Compass / ComNav Vector G1 GPS Satellite Compass used as GPS compass and Heaving sensor.

Refer to the installation manual of the Hemisphere V102 GPS Compass / ComNav Vector G1 GPS Satellite Compass for details of installation.

1.5.1 Connection of Hemisphere V102 GPS Compass / ComNav Vector G1 GPS Satellite Compass

Connect CW-376-5M by soldering with the cable of Hemisphere V102 GPS Compass / ComNav Vector G1 GPS Satellite Compass. (Hereafter referred to as "V102 GPS Compass") Please prepare two CW-376-5M when connecting with Radar as GPS compass.

- 1) The terminal of the cables of V102 GPS Compass is not processed, and 8 lead wires and 1 shield wire are open. Brown and blue lead wires are connected to TX/RX of Port A, white and green lead wires are connected to TX/RX of Port C, black and red lead wires are connected to +/- of power supply, and yellow lead wire is connected with earth. Orange lead wire and shield wire are unconnected.

Refer to the "Connection of V102 GPS Compass", and solder CW-376-5M with Port A and power supply of cable of Hemisphere V102 GPS Compass. Please solder another CW-376-5M with Port C, when connecting with Radar as GPS compass. Please branch yellow wire (GND) of the cable of V102 GPS Compass into four, two of which shall be soldered with each black (RX-) and red (TX-) of CW-376-5M. After soldering is completed, be sure to process the connected part by self-adhesive tape etc. to be water resistant and insulated.

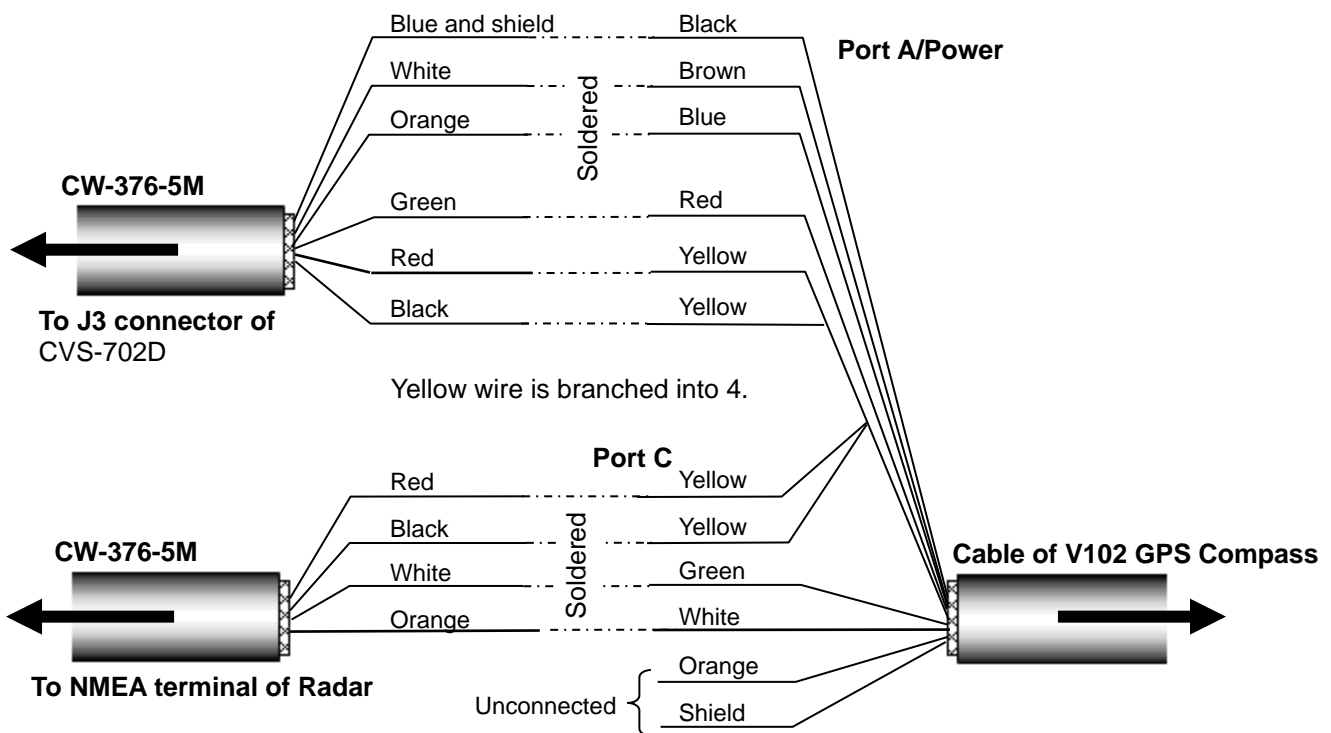

Connection of V102 GPS Compass

Connection table of V102 GPS Compass

Connectors to be connected		CW-376-5M Connected to J3		CW-376-5M Connected to Rader		V102 GPS Compass cable		
No.	J3	Color of cable	Signal of cable	Color of cable	Signal of cable	Color of cable	Signal of cable	Port
1	External power supply (-)	Blue and shield	GND	-	-	Black	PWGND	Port A
2	NMEA2 TX+	White	TX+	-	-	Brown	RX1+	
4	NMEA2 RX+	Orange	RX+	-	-	Blue	TX1+	
6	External power supply (+)	Green	+12V	-	-	Red	PWinput	
3	NMEA2 TX-	Red	TX-	-	-	Yellow	SigGND	Port C
5	NMEA2 RX-	Black	RX-	-	-			
No.	NMEA connector of Radar							
3	NMEA TX-	-		Red	TX-			
5	NMEA RX-	-		Black	RX-			
1	NMEA-	-		Blue and shield	-	-	-	
2	NMEA TX+	-		White	TX+	Green	RX2+	
4	NMEA RX+	-		Orange	RX+	White	TX2+	
6	NC	-		Green	-	-		



Caution: Wind the insulation tape around the unused lead wire to prevent core wires from contacting each other.

- 2) Connect CW-376-5M to J3 connector of CVS-702D (NMEA terminal with 12V power supply) after soldering with Port A.
- 3) Connect CW-376-5M to NMEA terminal of Radar after soldering with Port C when connecting with Radar as GPS compass. Refer to **“The general connection chart 1”**. Connect CW-376-5M to NMEA terminal of Plotter after soldering with Port C when connecting with the Plotter that can be communicated by 38400bps without Radar. Refer to **“The general connection chart 2”**.
In the other cases, connection with Port C is not necessary. Refer to **“The general connection chart 3”**.
- 4) Referring to **“The general connection chart 1 to 3”**, connect other equipment to communicate NMEA with the terminal J8 of CVS-702D.

Hemisphere V102 GPS Compass / ComNav Vector G1 GPS Satellite Compass

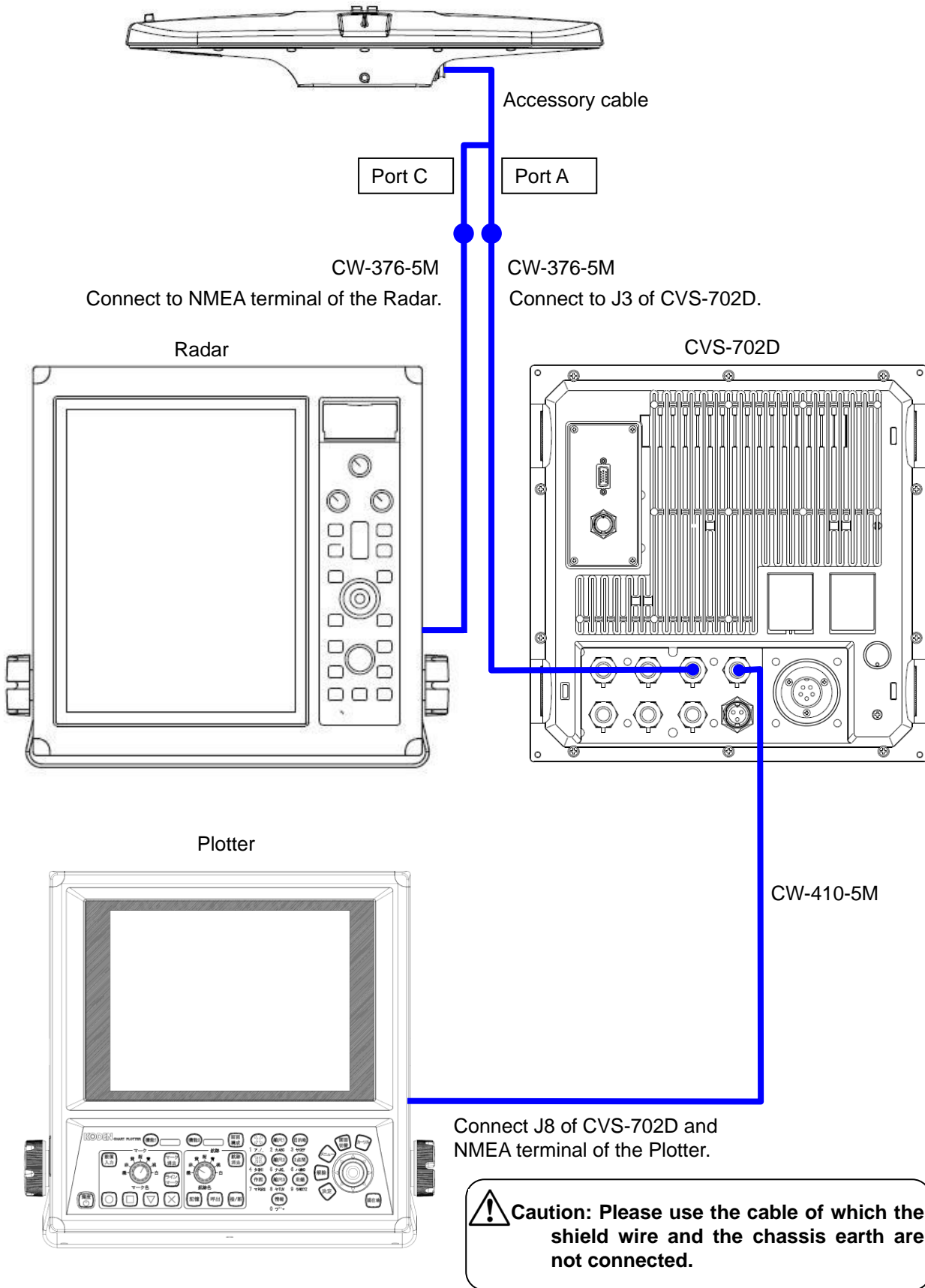

The general connection chart 1

Hemisphere V102 GPS Compass / ComNav Vector G1 GPS Satellite Compass

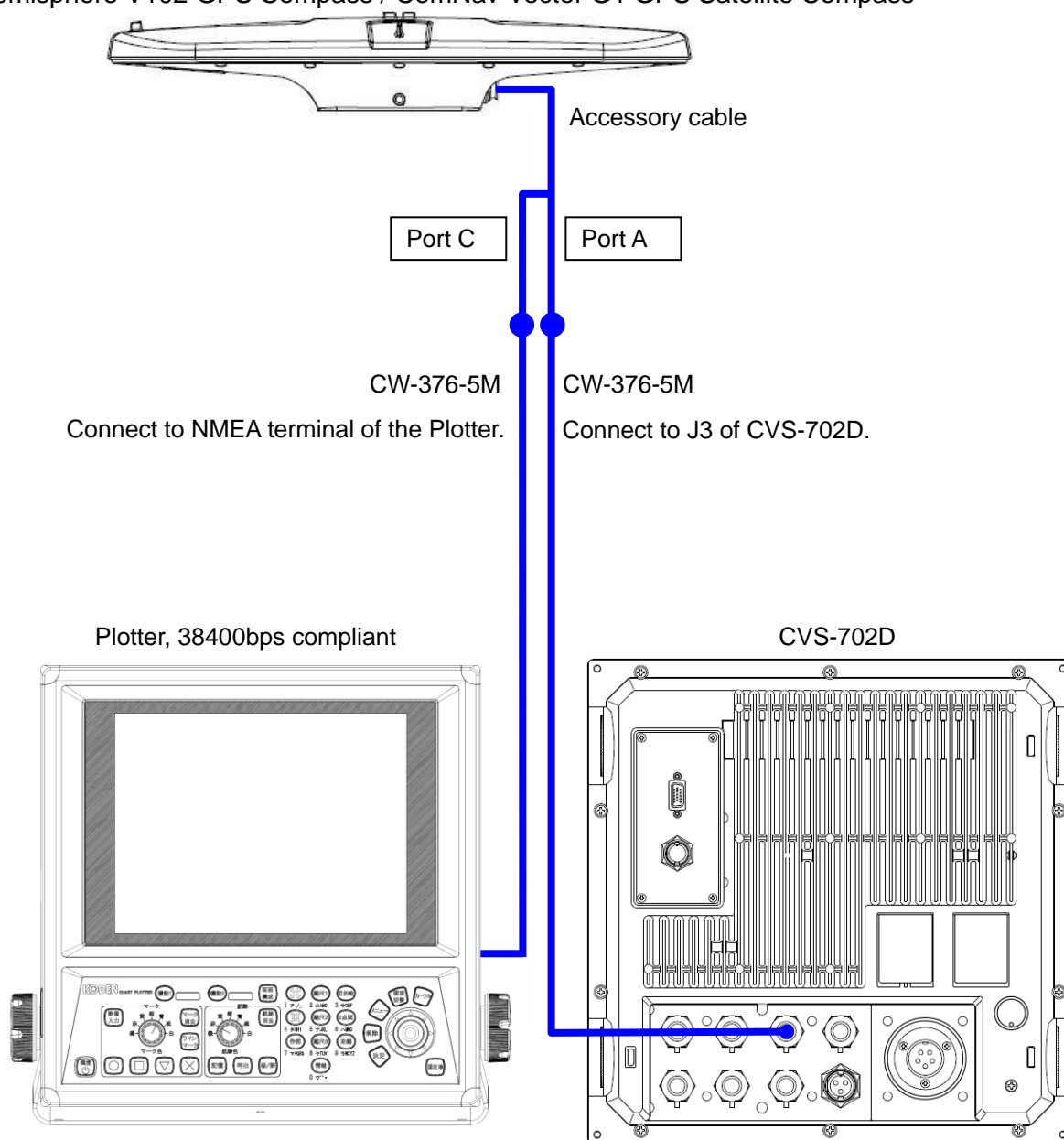

The general connection chart 2

Hemisphere V102 GPS Compass / ComNav Vector G1 GPS Satellite Compass

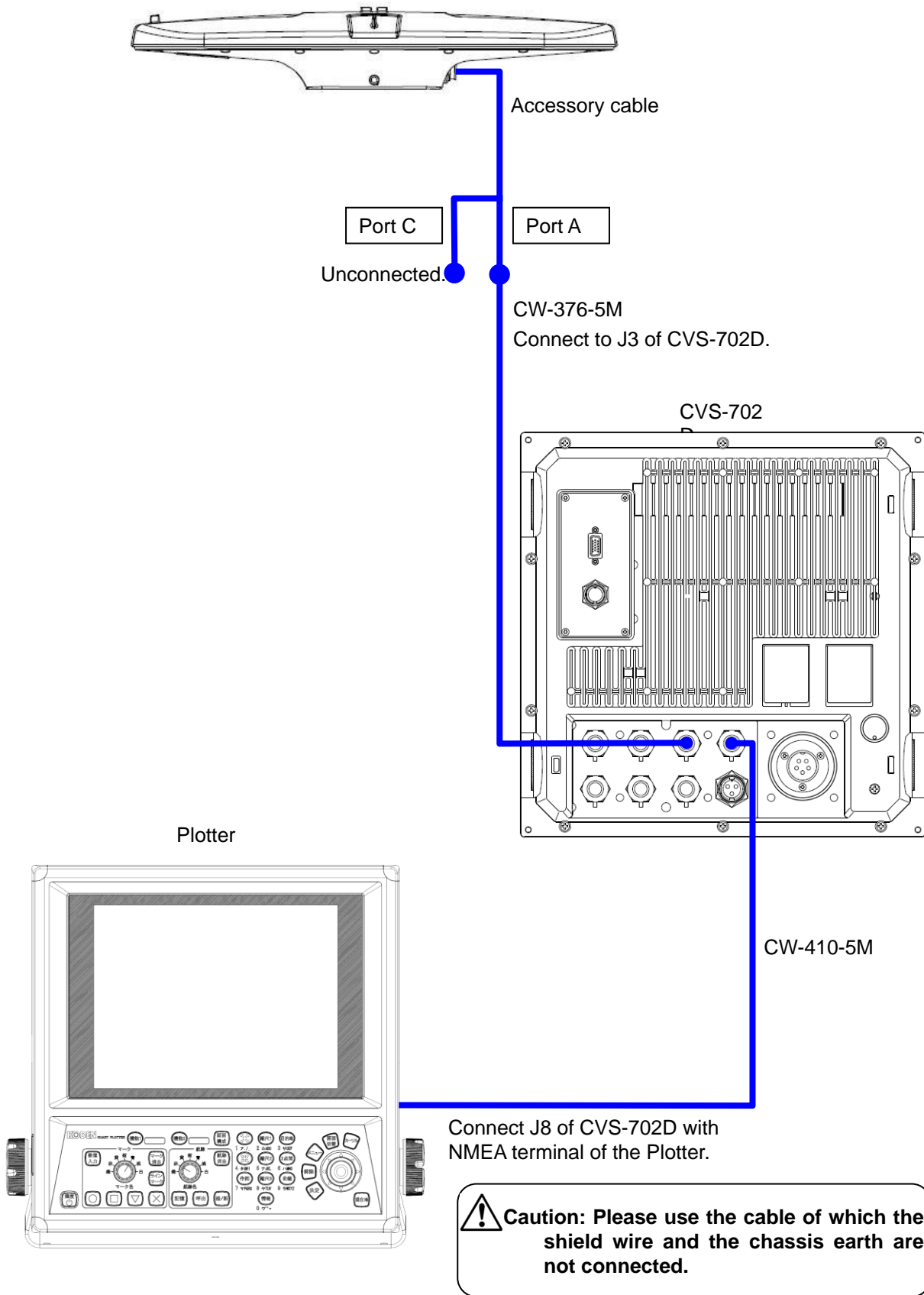

The general connection chart 3

1.5.2 Setting of Hemisphere V102 GPS Compass / ComNav Vector G1 GPS Satellite Compass

Hemisphere V102 GPS Compass / ComNav Vector G1 GPS Satellite Compass needs to be initialized to generate output data as GPS compass and Heaving sensor.

This can be done by setting by CVS-702D.

Hereafter, Hemisphere V102 GPS Compass / ComNav Vector G1 GPS Satellite Compass is referred to as "V102 GPS Compass".

1. To initialize V102 GPS Compass to generate output data as GPS compass and Heaving sensor:

- 1) Press , and the submenu is displayed.

System	Language	English
Source	Range&Speed Unit	NM, kn
NMEA 1	Depth Unit	m
NMEA 2	Temperature Unit	°C
Correct	Localtime Offset	9.0
Heaving	GPS Select	Others
TD Setting	GPS Initialize	No
Basics	Return	
Customize		
Maintain		
Network		
Sampling		
Sp. Adj.		

- 2) Select [Basics] - [GPS Select].

System	Language	English
Source	Range&Speed Unit	NM, kn
NMEA 1	Depth Unit	m
NMEA 2	Temperature Unit	°C
Correct	Localtime Offset	9.0
Heaving	GPS Select	Others
TD Setting	GPS Initialize	No
Basics	Return	
Customize		
Maintain		
Network		
Sampling		
Sp. Adj.		

3) Press [▶] of .

The setup box of [GPS Select] will be displayed.

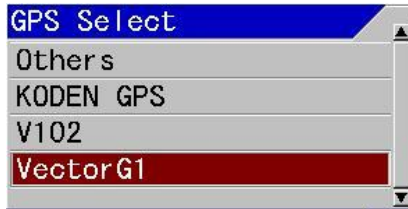

4) Press [▲] and [▼] keys, and select [V102] or [Vector G1].

5) Press  to return the [Basics].

System	Language	English
Source	Range&Speed Unit	NM, kn
NMEA 1	Depth Unit	m
NMEA 2	Temperature Unit	°C
Correct	Localtime Offset	9.0
Heaving	GPS Select	VectorG1
TD Setting	GPS Initialize	No
Basics	Return	
Customize		
Maintain		
Network		
Sampling		
Spc. Adj.		

6) Select [Basics] - [GPS Initialize].

System	Language	English
Source	Range&Speed Unit	NM, kn
NMEA 1	Depth Unit	m
NMEA 2	Temperature Unit	°C
Correct	Localtime Offset	9.0
Heaving	GPS Select	VectorG1
TD Setting	GPS Initialize	No
Basics	Return	
Customize		
Maintain		
Network		
Sampling		
Spc. Adj.		

- 7) Press [▶] of .

The setup box of [GPS Initialize] will be displayed.



- 8) Select [Yes] with [▲] and [▼] keys.

- 9) Press .

The message box of [It is processing] will be displayed .

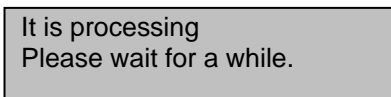

- 10) Once initialization is completed, the message box disappears and the display returns to the normal screen.

These steps complete the setup as follows:

The baud rate of NMEA2 (J3) of CVS-702D is set to 38400bps.

The baud rate of Port A of V102 GPS Compass is set to 38400bps, and Heaving data output is generated.

The baud rate of Port C of V102 GPS Compass is set to 38400bps, and GPS compass data output is generated.



Caution: It takes approximately 5 minutes until the heaving data of Hemisphere V102 GPS Compass / ComNav Vector G1 GPS Satellite Compass stabilizes after the start up. During the time, heaving correction may not be done correctly, however, this is not breakdown of the equipment.

2. This is to setup the output to the equipment to be connected on the NMEA1 (J8) ports of CVS-702D.

This is to set baud rate of J8 port.

Transmission rate shall match the externally connected equipment.

1) Press  .

2) Select [NMEA1] - [Baud Rate].

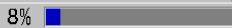
System	Baud Rate	4800bps
Source	DBT Output	OFF
NMEA 1	DPT Output	ON
NMEA 2	GGA Output	OFF
Correct	MTW Output	ON
Heaving	TLL Output	OFF
TD Setting	VHW Output	OFF
Basics	VTG Output	OFF
Customize	ZDA Output	OFF
Maintain	GLL Output	OFF
Network	HDT Output	OFF
	MWV Output	OFF
	RMC Output	OFF
	Return	
	8%	

3) Press  of  .

The setup box of [Baud Rate] will be displayed.

Baud Rate
4800bps
9600bps
19200bps
38400bps

4) Press [>] and [>] to select the Baud Rate of NMEA1.

5) Press  to return the [NMEA1].

This is to select output data of NMEA1.
Output data shall match the externally connected equipment.

- 1) Select [NMEA1] - [XXX Output].

System	Baud Rate	4800bps
Source	DBT Output	OFF
NMEA 1	DPT Output	OFF
NMEA 2	GGA Output	ON
Correct	MTW Output	OFF
Heaving	TLL Output	OFF
TD Setting	VHW Output	OFF
Basics	VTG Output	OFF
Customize	ZDA Output	OFF
Maintain	GLL Output	OFF
Network	HDT Output	OFF
Sampling	MWV Output	OFF
Sp. Adj.	RMC Output	OFF
	Return	
	0%	



- 2) Press [▶] of



.

The setup box of [XXX Output] will be displayed.



- 3) Select [ON] to enable the output and select [OFF] to disable with [▲] and [▼] keys.
- 4) Press  to return the [NMEA1].
- 5) When another output data is set, repeat 1) to 4).
- 6) When the setting is completed, press  to close the [submenu].

Annex

Default value of Hemisphere V102 GPS Compass

Port A

Baud rate	19200bps					
NMEA sentence	GPGLL	GPVTG	GPZDA	GPZDA	GPHDT	GPROT
TX interval	1sec	1sec	1sec	1sec	1sec	1sec

Port C

Baud rate	19200bps					
NMEA sentence	GPGLL	GPVTG	GPZDA	GPZDA	GPHDT	GPROT
TX interval	1sec	1sec	1sec	1sec	1sec	1sec

Default value of ComNav Vector G1 GPS Satellite Compass

Port A

Baud rate	4800bps					
NMEA sentence	GPGLL	GPVTG	GPZDA	GPZDA	GPHDT	GPROT
TX interval	1sec	1sec	1sec	1sec	1sec	1sec

Port C

Baud rate	4800bps		
NMEA sentence	GPHDM	GPHDT	GPVTG
TX interval	0.1sec	0.1sec	1sec

The Hemisphere V102 GPS Compass / ComNav Vector G1 GPS Satellite Compass setting after initialization by CVS-702D

Port A

Baud rate	38400bps					
NMEA sentence	GPGLL	GPVTG	GPZDA	GPHDT	GPHEV	GPHPR
TX interval	1sec	1sec	1sec	0.1sec	0.1sec	0.1sec

Port C

Baud rate	38400bps					
NMEA sentence	GPGLL	GPVTG	GPZDA	GPHDT	GPZDA	GPGSV
TX interval	1sec	1sec	1sec	0.1sec	1sec	1sec

1.6 List of input/output sentences

1.6.1 Input sentence

The sentences of GGA, GLL, HDT, MTW, MWV, MWD, RMC, VHW, VTG and ZDA can be received.

Possible input formats are: NMEA0183 Ver.1.5, Ver.2.0 and Ver.3.00

Information	Priority Order of sentence	Information	Priority Order of sentence
Latitude, Longitude	GGA > RMC > GLL	Wind Direction	MWV > MWD
Course	VTG > RMC	Wind speed	MWV > MWD
Heading	HDT > RMC > VTG	Date	ZDA > RMC
Ground Speed	RMC > VTG	Time	ZDA > RMC
Water Speed	VHW > RMC > VTG	Water temperature	MTW

1.6.2 Output sentence

The sentences of DBT, DPT, GGA, GLL, HDT, MTW, MWV, RMC, TLL, VHW, VTG and ZDA can be transmitted.

The output format is NMEA0183 Ver.2.0. However, the DBT output is in Ver.1.5.

Sentence	Information	Sentence	Information
DBT	Depth from the transducer	MWV	Wind Direction, Wind Speed
DPT	Depth from the transducer, Draft	RMC	Latitude/Longitude, Course, Ground Speed, Date
GGA	Latitude/Longitude, Time	TLL	Target Position
GLL	Latitude/Longitude	VHW	Water Speed
HDT	Heading	VTG	Course, Ground Speed
MTW	Water temperature	ZDA	Date, Time

- This page intentionally left blank.-

Chapter 2 Adjustment

2.1 Setup of transducer

The frequency and beam angle etc. per transducer will be conformed to those of the transducer to be used, then, the correct information can be provided.

System	HF TD Type	TD Selection
Source	LF TD Type	TD Selection
NMEA 1	HF TD1 Setting	▶List
NMEA 2	HF TD2 Setting	▶List
Correct	HF TD1 Setting	▶List
Heaving	LF TD2 Setting	▶List
TD Setting	Bottom Limit HF	1.0m
Basics	Bottom Limit LF	1.0m
Customize	Return	
Maintain		
Network		

2.1.1 Setup of type of high frequency transducer

TD Setting – HF TD Type

Select the type of transducer to be actually used in high frequency. It has to be adjusted as it has influence on images.

1. Press **SUB MENU**.
2. Select [TD Setting] - [HF TD Type].
3. Press of [▶] of .

The setup box of [HF TD Type] will be displayed.

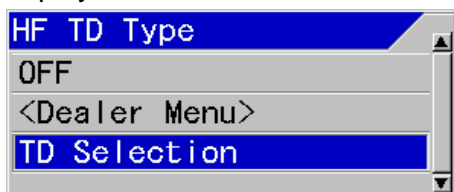

4. Press [▲] and [▼] to select [TD Selection]. When a high frequency transducer is not used, select [OFF].

5. Press of [▶] of .

When [TD Selection] is selected, the

setup box of [TD Selection] will be displayed.

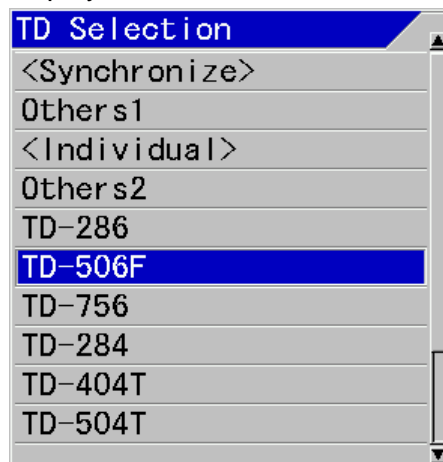

Select transducer model to be used. When unlisted transducer is used, select [Others1] or [Others2].

When [Others1] is selected, one high-frequency and one low-frequency can be set up.

When [Others2] is selected, two high-frequencies and two low-frequencies can be set up.

6. Press [▲] or [▼] to select the type of transducer to use.
7. Press **ENT**.

The setup box of [TD is set.] will be displayed.

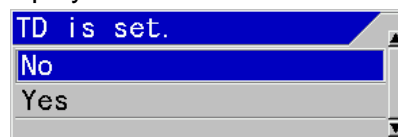

8. Select [Yes] with [▲] and [▼] keys.
9. Press **ENT**.

A message "It is processing" will be displayed.

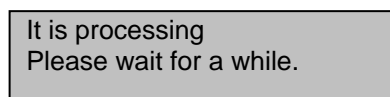

After a while the menu will close and display returns to [TD Setting] menu.

10. Press **MENU** to close the menu.

2.1.2 Setup of type of low frequency transducer

TD Setting – LF TD Type



Select the type of transducer to be actually used in low frequency. It has to be adjusted as it has effect on images.

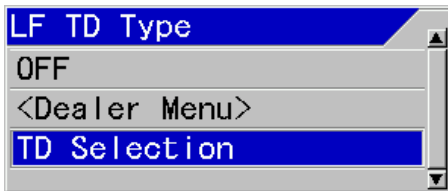

1. Press  .
2. Select [TD Setting] - [LF TD Type].

3. Press  of  .

The setup box of [LF TD Type] will be displayed.



4. Press  and  to select [TD Selection]. When a low frequency transducer is not used, select [OFF].

5. Press  of  .

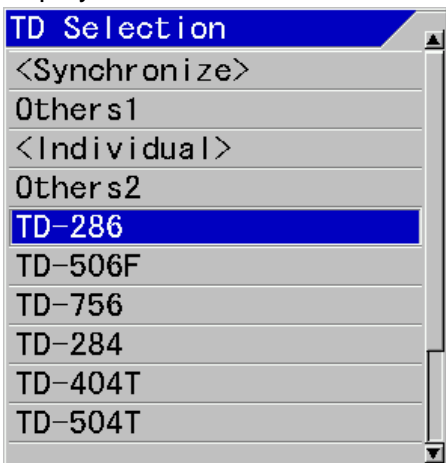

When [TD Selection] is selected, the setup box of [TD Selection] will be displayed.



Select transducer model to be used. When unlisted transducer is used, select [Others1] or [Others2].

When [Others1] is selected, one high-frequency and one low-frequency can be set up.

When [Others2] is selected, two high-frequencies and two low-frequencies can be set up.

6. Press  or  to select the type of transducer to use.

7. Press  .

The setup box of [TD is set.] will be displayed.

8. Select [Yes] with  and  keys.

9. Press  .

A message “It is processing” will be displayed.

And, after a while the menu will close and display returns to [TD Setting] menu.

10. Press  to close the menu.

2.2 Setup of frequency of transducer

The high or low frequency can be setup for transducer frequency.

When the transducer listed in the [TD selection] is selected, [Frequency] will be set automatically.



When [Ohter1] or [Other2] is selected, [Frequency] should be set manually. Therefore you need to find out the [Frequency].

2.2.1 Setup of frequency for high frequency transducer

TD Setting – HF TD1 Setting

1. Press  .

2. Select [TD Setting] – [HF TD1 Setting].

3. Press  of  .

The setup box of [HF TD1 Setting] will be displayed.

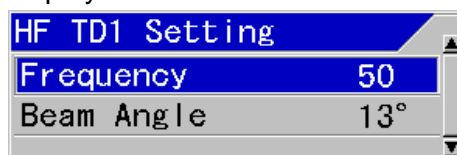

4. Press [▲] or [▼] to select [Frequency].
5. Press [▶].

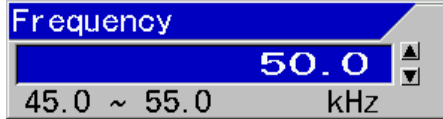

The setup box of [Frequency] will be displayed.



The range of selectable frequency depends on the connected transducers.

6. Press [▲] or [▼] to select [Frequency].
7. Press  to close the menu.

TD Setting – HF TD2 Setting



1. Press  .
2. Select [TD Setting] – [HF TD2 Setting].
3. Press [▶] of  .

The setup box of HF TD2 Setting will be displayed.

4. Set as the same way as HF TD1 Setting.
5. Press  to close the menu.

2.2.2 Setup of frequency for low frequency transducer

TD Setting – LF TD1 Setting

1. Press  .
2. Select [TD Setting] – [LF TD1 Setting].
3. Press [▶] of  .

The setup box of [LF TD1 Setting] will be displayed.

4. Set as the same way as [HF TD1 Setting].
5. Press  to close the menu.

TD Setting – LF TD2 Setting

1. Press  .
2. Select [TD Setting] – [LF TD2 Setting].

3. Press [▶] of  .

The setup box of [LF TD2 Setting] will be displayed.

4. Set as the same way as [HF TD1 Setting].
5. Press  to close the menu.

2.3 Setup of Beam Angle of transducer



The beam angle of the transducer of high and low frequencies can be set.

When the transducer listed in the [TD selection] is selected, [Beam angle] will be set automatically.

When [Ohter1] or [Other2] is selected, [Beam angle] should be set manually. Therefore you need to find out the [Beam angle].

2.3.1 Setup of Beam Angle for high frequency transducer

TD Setting - HF TD1 Setting

1. Press  .
2. Select [TD Setting] – [HF TD1 Setting].
3. Press [▶] of  .

The setup box of [HF TD1 Setting] will be displayed.

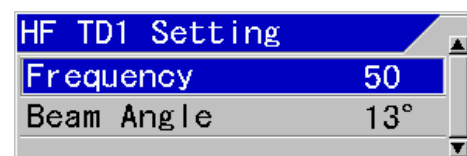

4. Press [▲] or [▼] to select [Beam Angle].

5. Press [▶].

The setup box of [Beam Angle] will be displayed.



6. Press [▲] or [▼] to set [Beam Angle].

7. Press **MENU** to close the menu.

Caution: The setup of beam angle is reflected on the display of detecting range and will not change the actual beam angle.

TD Setting - HF TD2 Setting

1. Press **SUB MENU**.

2. Select [TD Setting] – [HF TD2 Setting].

3. Press [▶] of .

The setup box of [HF TD2 Setting] will be displayed.

4. Set as the same way as [HF TD1 Setting].

5. Press **MENU** to close the menu.

Caution: The setup of beam angle is reflected on the display of detecting range and will not change the actual beam angle.

2.3.2 Setup of Beam Angle for low frequency transducer

TD Setting - LF TD1 Setting

1. Press **SUB MENU**.

2. Select [TD Setting] – [LF TD1 Setting].

3. Press [▶] of .

The setup box of [LF TD1 Setting] will be displayed.

4. Set as the same way as [HF TD1 Setting].

5. Press **MENU** to close the menu.

Caution: The setup of beam angle is reflected on the display of detecting range and will not change the actual beam angle.

TD Setting - LF TD2 Setting

1. Press **SUB MENU**.

2. Select [TD Setting] – [LF TD2 Setting].

3. Press [▶] of .

The setup box of [LF TD2 Setting] will be displayed.

4. Set as the same way as [HF TD1 Setting].

5. Press **MENU** to close the menu.

Caution: The setup of beam angle is reflected on the display of detecting range and will not change the actual beam angle.

2.4 Setup of Bottom Limit

If the Bottom Limit is designated, the depth shallower than the designated water depth is not detected as sea bottom.

2.4.1 Setup of Bottom Limit HF

TD Setting –Bottom Limit HF

To set Bottom Limit of high frequency.

1. Press **SUB MENU**.

2. Select [TD Setting] - [Bottom Limit HF].

3. Press [▶] of .

The setup box of [Bottom Limit HF] will be displayed.



4. Press [▲] and [▼] to set a depth.
5. Press **MENU** to close the menu.

2.4.2 Setup of Bottom Limit LF

TD Setting –Bottom Limit LF

To set Bottom Limit of low frequency.

1. Press **SUB MENU**
2. Select [TD Setting] - [Bottom Limit LF]

3. Press [▶] of

The setup box of [Bottom Limit LF] will be displayed.

4. Press [▲] and [▼] to set a depth.
5. Press **MENU** to close the menu.

2.5 Setup of Draft Set

Correct - Draft Set

This is to set the depth between the sea surface and the depth of transducer instated. Normally, it is the draft of the boat to be installed.

(Setting range: except for ft: - 10.0 ~ 10.0, in ft: - 30.0 ~ 30.0)

1. Press **SUB MENU**
2. Select [Correct] - [Draft Set].

3. Press [▶] of

The setup box of [Draft Set] will be displayed.

4. Press [▲] or [▼] to set a draft.
5. Press **MENU** to close the menu.

2.6 Setup of Gain (TD) for transducer

Correct – Gain (TD)

The insufficient gain due to ultrasonic signal attenuation can be corrected. Accuracy of bottom detection is adjusted. Such false recognition can be corrected that a deeper position is recognized as sea bottom than actual, or large fish school is recognized as sea bottom.

Caution: In case of inner-hull installation the set value of gain (TD) varies depending on the materials of bottom of the ship and the processing method. In some cases, low frequency cannot be used due to too much attenuation of ultrasonic signal at ship's bottom.

1. Press **SUB MENU**
2. Select [Correct] – [Gain (TD)].

3. Press [▶] of

The screen will turn to the gain (TD) adjustment screen and displays the gain (TD) setup box at the upper side of the screen.

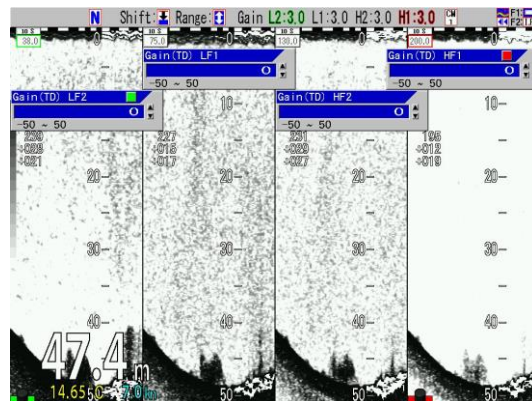

4. Setup the Gain (TD) by turning the gain knob, which are lighted red or green, at the side to be adjusted.

When a red square mark appears at right side upper corner of the Gain (TD) setup box, the red lighted gain knob shall be operated. When there is a green square mark, turn the green lighted gain knob.

This part is lighted red or green

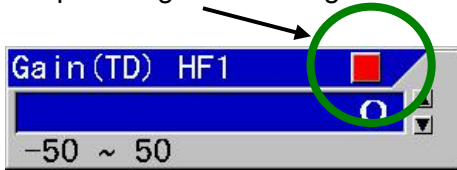

The gain (TD) setting shall be adjusted in such a way that the white line in sea bottom has the same thickness as that of the strongest signal color area.

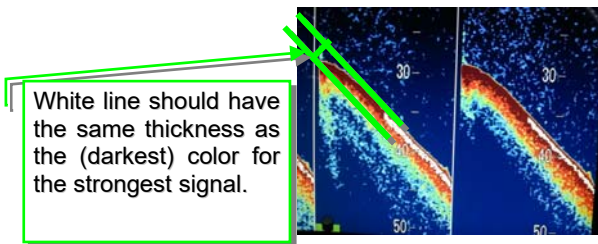

- Pressing the gain knob at the side to be adjusted a few times, move to the position of the Gain (TD) box to be adjusted. (the red mark at right top side will move)

When there are more than 2 screens, press the gain knob at the screen to be adjusted. The gain knob pressed will turn red. (The center screen of 3 screens will be the right side screen)

- Press **MENU** to close the menu.

2.7 Setup of Output Limit for transmitter

Set the output limit, when you connect a non-standard low output power TD.

System	Gain(TD) Offset H1	0
Source	Gain(TD) Offset H2	0
NMEA 1	Gain(TD) Offset L1	0
NMEA 2	Gain(TD) Offset L2	0
Correct	Palette Change	1410 type
Heaving	Output Limit (HF)	60
TD Setting	Output Limit (LF)	50
Basics	Digitra	OFF
Customize	Heaving Info.	OFF
Maintain	IR Adjust	60
Network	BTM Adjust	▶List
Digitra	BTM DET Adjust	▶List
Sampling	Return	
Spc. Adj.		

2.7.1 Display of Output Limit Menu

- If the power supply is ON, turn OFF the power supply by long press of the **BRILL** key.
- Press **BRILL** key, while keeping **MENU** key, and **F1** key at the same time, to turn ON the power supply.
- Press **SUB MENU** key after the normal image is displayed.
- [Sp. Adj.] appears at the bottom of the submenu list.

2.7.2 Setup of Output Limit HF

- Please display the [Sp. Adj.] at the bottom of the submenu list. (Refer to 2.7.1 Display of Output Limit Menu)
- Press **SUB MENU**.
Select [Sp. Adj.] - [Output Limit HF].
- Press **▶** of

The setup box of [Output Limit HF] will be displayed.

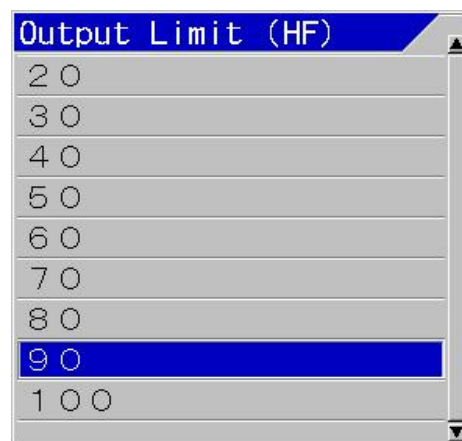

- Press **▲** or **▼** to set an output limit.

Caution: Set the value at 60 for the transducer of 1kW.

- Press **MENU** to close the menu.

2.7.3 Setup of Output Limit LF

1. Please display the [Sp. Adj.] at the bottom of the submenu list.(Refer to 2.7.1 Display of Output Limit Menu)

2. Press .

Select [Sp. Adj.] - [Output Limit LF].

3. Press [▶] of .

The setup box of [Output Limit LF] will be displayed.

4. Press [▲] or [▼] to set an output limit.

 **Caution: Set the value at 60 for the transducer of 1kW.**

5. Press  to close the menu.

2.7.4 Relation of the set value between [Output Limit] and [MENU] - [Echo Adjust] - [TX Power]

[Output Limit] is a common setting regardless of CM key.

A set value of [TX Power] is applicable individually to each CM key.

[Output Limit] limits the output that becomes the source of [TX power].

The value of [TX Power] represents the percentage out of the value set by [Output Limit] as 100%.

For instance, when the value of [Output Limit] is 60, and the value of [TX Power] is 90, actual output is 90% of the output limited to 60% from the original output power.

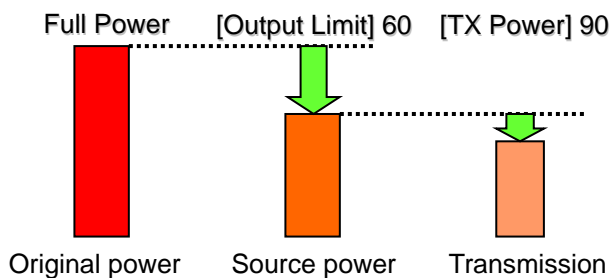

- This page intentionally left blank.-

Chapter 3 Maintenance

3.1 Inspection

The daily maintenance and inspection extend the life of equipment. To keep the equipment always in the best conditions, implement the periodical inspection shown in the table below.

Item	Inspection item
Connectors at the rear of the Display unit	Check the looseness
Wiring of cables	Check the wiring of cables connecting the equipment and the damage of cable
Grounding of Display unit	Scrape the rust off the ground terminal and keep good contact.

3.2 Cleaning

3.2.1 Display unit

Contamination on the screen may cause faint images. For cleaning the screen, wipe it with soft and clean cloth dipped in diluted neutral detergent. Pay full attention as the screen gets scratched easily. No solvent such as thinner shall be used.



Caution

The display screen has a special coating. Do not use a solvent such as paint thinner, acetone, alcohol, and benzene, etc. Strong rubbing may cause scratch.

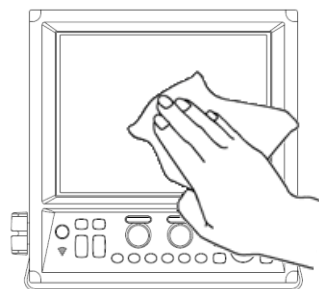

For cleaning the chassis, do not use solvent such as thinner or alcohol. Painting on the surface and characters at the operating unit may be dissolved. After wiping with soft and clean cloth dipped with diluted neutral detergent, wipe away with dry soft and clean cloth.

3.2.2 Transducer

In the case of the through-hull installation, check the surface of opening of transducer (portion from which the ultra-sonic is emitted). If shells or oil adhere, scrub the surface with a wooden or bamboo knife with caution not to damage the surface and remove stuck materials. If you scrub strongly, the surface will be damaged, resulting in deteriorated performance of transducer.

3.3 Fuse Replacement

**Warning**

Use the specified fuse. If you use a fuse other than specified one, it may lead to a serious accident.

Fuse blows out when such a trouble occurs inside at too high input voltage or over current. The fuse is located in the power cable. Please replace with the fuse listed in the list of standard components.

3.4 Diagnostics of troubles

In this section, simple procedures to find out troubles are mentioned to locate the troubles on boat.

3.4.1 Necessary information for requesting repair

Please inform of the following points:

- (1) Name of the ship, and telephone number, if a satellite communication system is equipped,
- (2) Failed equipment name and type name
- (3) Equipment serial number
- (4) "Version number. of system software" displayed on "Title screen"
- (5) Next calling port and name of sales agent, telephone number, Fax number, e-mail address, etc.
- (6) Details of failure (as much as possible) and failure diagnostics results on board, as well as operation conducted, in particular, until the failure or when the failure occurred.

3.4.2 Diagnostics

As self diagnostics, panel test and LCD test can be performed.

As panel test, the present conditions of the system will be displayed at the upper side of the display screen in addition to confirmation of key inputs.

As LCD test, display will be switched over in the order of grid, white, black, red, green and blue each time the corresponding key is pressed.



1. Press **SUB MENU**.
2. Select [Maintain] – [System Check].



3. Press [▶] of

The setup box of [System Check] will be displayed.

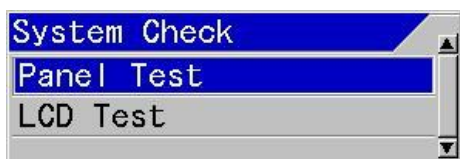

4. When panel test or confirmation of system conditions is performed, select [Panel Test] with [▲] and [▼] keys. For checking of LCD, select [LCD Test].
5. Press [▶].

When [Panel Test] is selected, the panel test screen will be displayed.

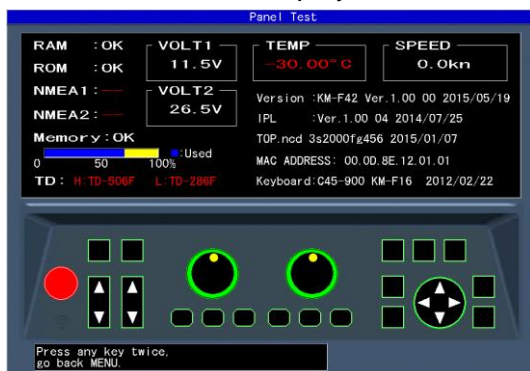

The system conditions will be displayed as shown in the above figure.

When a key is pressed, the key will be identified and the key on the corresponding

screen will change in color. The same key is pressed subsequently, the System Test screen will end and the setup box of [System Check] will be displayed.

Caution: The LED on panel will turn from green to red if the gain knob is rotated to right or left, or one of CM1 ~ CM6 is pressed and one more pressing will turn the color to green. In addition, the internal buzzer will sound when the gain knob is rotated.

- (1) [RAM] displays the result of RAM check. OK if normal, and NG if abnormal, will be displayed.
- (2) [ROM] displays the result of ROM check. OK if normal, and NG if abnormal, will be displayed.
- (3) [NMEA1] confirms J8 port. As the confirmation will be performed when the panel test screen is displayed, mount the jig before the display of the screen.
“—” for not yet done, OK for normal case and NG for abnormal case will be displayed.
- (4) [NMEA2] confirms J3 port. As the confirmation will be performed when the panel test screen is displayed, mount the jig before the display of the screen.
“—” for not yet done, OK for normal case and NG for abnormal case will be displayed.

Caution: For confirmation of [NMEA1] and [NMEA2] ports, the dedicated jig is necessary.

- (5) [Memory] displays the conditions of internal memory. Ok for normal case and NG for abnormal case will be displayed. The used ratio of memory is also displayed.
- (6) [VOLT1] displays the voltage value of + 12 V line. When the voltage falls in abnormal range, the indication will be in red.
- (7) [VOLT2] displays voltage of power input line. When this voltage falls in abnormal

range, alarm will sound and an alarm message will be displayed.

When the voltage falls in abnormal range, the indication will be in red.

- (8) [TEMP] displays water temperature of the water temperature sensor.
In the case of non connection, - 30.0 in red will be displayed.
- (9) [SPEED] displays the speed of the boat's speed sensor.
In the case of abnormality, display will be in red.
- (10) [Version] displays the version No. of the system software.
- (11) [IPL] displays the version No. of IPL version.
- (12) [Top.ncd] will display the version No. of FPGA data.
- (13) [MAC ADDRESS] displays MAC address used in network.



3.4.3 LCD Test

Display the setup box for [System Check] in the same way as for [Panel Test], and select [LCD Test].When [▶] is pressed, the grid will be displayed.

Each time [▶] key is pressed, the color of display will change, and displays finally the setup box of [System Check].

3.4.4 Initialize

This is to return all setup of each CM or the whole system to the factory default settings. However, waypoint data and image stored data will remain as they are.

- 1. Press  .
- 2. Select [Maintain] – [Initialize]
- 3. Press [▶] of  .

The setup box of [Initialize] will be displayed.



- 4. When an specified CM is to be initialized, select [CM1] to [CM6] with [▲] and [▼] keys. To initialize the whole system, select [System ALL].

When one of [CM1] to [CM6] is selected, the set values commonly used at each CM such as selected language and units will not be initialized.

When [System ALL] is selected, all setup values including the values commonly used at each CM will be initialized.

- 5. Press [▶].
The setup box of [CM initialize] will be displayed.
- 6. When initialization is performed, select [Yes] for initialization by pressing [▲] and [▼] keys, and [No] for not to initialize.
- 7. Press  .

At [Yes], initialization will be performed.
At [No], the menu will be closed.

 **Caution: When [System All] is selected, the display will be in English after initialization.**

3.4.5 Update of program

This is used for program update.
(Please consult your sales agent)

- 1. Press  .
- 2. Select [Maintain] – [System Program Load].

3. Press [▶] of .

The setup box of [System Program Load] will be displayed.

4. When program is to be updated, select [Yes] and is not to be updated, select [No] with [▲] and [▼] keys.

5. Press .

When [Yes] is selected, program will be in updating condition and a message "Updating

Do not Power Off." will be displayed.

When [No] is selected, returns to the menu.

6. The program will be downloaded from USB ROM writer or PC.

When downloading has started, [CM] keys will blink red in the order of CM1 to CM6.

At completion of downloading, the both gain knobs will be lighted red.

7. Pressed  for about 5 seconds to switch off the power.



Caution: When program updating failed on the way, switch off the power once and switch on again. It will start up in the wait status of downloading. Try again the procedures from step 6 again.

3.5 If you suspect a trouble

Symptom	Possible cause of trouble	Measure
Even with power on, nothing is displayed.	<ul style="list-style-type: none"> • Fuse is blown. • Power voltage is out of specification (10.8 to 31.2 VDC) • Poor connection between power cable and battery 	<ul style="list-style-type: none"> • Replace the fuse (See “3.3 Fuse Replacement”, page 3-2. • Use a proper power as per specification. • Check the connection between power cable and battery.
After starting up, nothing is displayed	<ul style="list-style-type: none"> • Poor connection between transducer and Display unit • Failure of LCD display panel 	<ul style="list-style-type: none"> • Check the connection between transducer and Display unit. • Consult a repair shop or sales agent.
Much interference noise	<ul style="list-style-type: none"> • Improper installation of transducer • Interference from the echo sounder on other boats. 	<ul style="list-style-type: none"> • Check the installed position of transducer (See “1.3 Installation of transducer”, page 1-6. • Implement interference rejection.
Display of water temperature / Speed is abnormal or not displayed.	<ul style="list-style-type: none"> • Poor connection of sensors connectors • Input sources may be abnormal. 	<ul style="list-style-type: none"> • Check the connection at sensor connectors. • Check the input sources.
Display of present location/course is abnormal or not displayed.	<ul style="list-style-type: none"> • Poor connection between this unit and navigation equipment 	<ul style="list-style-type: none"> • Check the connection between this unit and navigation equipment.



Koden Electronics Co., Ltd.

Tamagawa Office:

2-13-24 Tamagawa, Ota-ku, Tokyo, 146-0095 Japan

Tel: +81-3-3756-6501 Fax: +81-3-3756-6509

Uenohara Office:

5278 Uenohara, Uenohara-shi, Yamanashi, 409-0112 Japan

Tel: +81-554-20-5860 Fax: +81-554-20-5875

www.koden-electronics.co.jp