

**COLOR LCD FISH FINDER**

**CVS-106L**

**OPERATION MANUAL**

**SITEX<sup>®</sup>**

DOC NO CVS106L 7-01  
93132664-00

---

# Table of contents

Important Notice .....	i	MENU 2/3 .....	16
Color sounder (chromascope)-		Selecting a color tone for the image display .....	16
How it works- .....	1	Changing the background color .....	16
Name .....	2	Turning on or off the alarm, and selecting the bottom	
Getting started.....	3	or fish alarm .....	16
Displaying the normal image .....	3	Selecting an upper depth limit for the alarm .....	16
Shifting the depth range .....	5	Selecting an lower depth limit for the alarm .....	16
Shifting the depth range .....	5	Setting the magnitude (Color) of fish image signal	
Selecting the Auto Shift .....	5	for activating the fish alarm .....	16
Selecting multiple image .....	6	Setting a size (Length) of schools of fish for activating	
Single frequency .....	6	the fish alarm .....	17
Dual frequency .....	6	Setting the bottom alarm .....	17
Displaying the zoom image .....	7	Setting the fish alarm .....	17
Switching the zoom range .....	7	MENU 3/3 .....	18
Switching the zoom position .....	8	Adjusting the effect of auto gain .....	18
Relationship between Zoom Range/Zoom Position		Displaying boat position when a navigator is	
and Depth Range/Shift .....	8	interfaced .....	18
Turning on or off displaying of the A-scope .....	9	Selecting unit of boat speed .....	18
Measuring depth by VRM (green) .....	9	Selecting unit of water temperature .....	18
Storing event data .....	10	Turning on or off display of the water temperature	
Menus .....	11	graph .....	18
Type of menus .....	11	Resetting the Trip Mileage .....	18
Calling the menu .....	11	Clearing event data .....	18
Menu and key function .....	11	Troubleshooting .....	19
Returning to display mode .....	11	Specifications .....	19
Opening INITIAL MENU 1/2 .....	11	Major specifications .....	19
Selecting unit of measure .....	11	Standard equipment .....	20
Selecting the bottom zoom .....	11	Outline and dimensions .....	20
Matching to the boat draft .....	11	Installation .....	21
Switching the split screen layout between horizontal		Mounting display unit .....	21
and vertical display .....	12	Plug pin arrangement .....	21
Simulated picture .....	12	NMEA0183 output data format	
Selecting a display language .....	12	Ver.1.5/2.0 .....	22
Opening INITIAL MENU 2/2 .....	12	Certificate of Limited Warranty .....	23
Correcting the sonic velocity .....	12	How to Obtain Service under This Warranty .....	23
Selecting a boat speed data source .....	12		
Correcting a displayed boat speed .....	13		
Selecting a water temperature data source .....	13		
Correcting a displayed water temperature .....	13		
Selecting an input data format .....	13		
MENU 1/3 .....	14		
Adjusting the operation panel illumination .....	14		
Turning On or Off the enlarged Character Display .....	14		
Deleting interferences from other boats .....	14		
Displaying the white line on the bottom surface .....	14		
Eliminating undersired colors .....	15		
Specifying a depth for the bottom detection .....	15		
Changing the output pulse width .....	15		



## Installation Precautions <For Service Personnel>

Follow the installation instructions to avoid personal injury and system malfunction.

<b>Install in rigid position</b>	Mount your system on a rigid frame or ceiling to prevent damage from loosening.
<b>Use correct installation materials.</b>	Use the installation materials in the standard accessory pack only. If a bolt or screw strength is insufficient, your system may fall and be damaged.
<b>Keep away from direct sunlight.</b>	Keep your system away from direct sunlight to prevent damage from overheating.
<b>Keep away from water.</b>	Keep your system dry. Water could damage this unit and also cause electrical shock.
<b>Keep away from heat source.</b>	Keep your system away from a heat source or it may malfunction, become damaged, or burn.
<b>Use correct power source.</b>	Operate your system with the specified power voltage. An incorrect power supply may cause a malfunction, fire or personal injury.



## Maintenance Cautions <For Maintenance Personnel>

Use the following safety precautions during internal inspection.

<b>Discharge capacitors.</b>	A high voltage may remain in the capacitors of the high-tension circuit several minutes after you have turned the power switch off. Wait at least five minutes or discharge them to ground before starting your inspection.
<b>Check that power is OFF.</b>	To prevent an electrical injury due to erroneous power switching, make sure that the main power supply and the system power switch are both off. Also attach a safety label showing that service is in progress.
<b>Avoid static electricity.</b>	Take care not to damage the ESDs (Electrostatic Sensitive Devices) due to static electricity from carpet and cloths.
<b>Avoid dust.</b>	Wear a safety mask so as not to breath in dust during inspection or cleaning inside your system instruments.

## Operation Notes <For Operators>

Observe the following operation notes, otherwise system failure or deterioration can result. Periodical inspection and maintenance are required for keeping the system in an optimum condition.

<b>Backup important data.</b>	Save or log important data in a backup memory or log sheets. The initial setup data and your storage data may be lost when the internal battery expires or when you service the electrical circuits.
<b>Keep away magnetic substances.</b>	Keep away magnetic substances such as magnets or magnetized tools from the display unit, otherwise dislocation of displayed image can result.
<b>Use correct transducer only.</b>	If you use a non-specified transducer, the transmitter circuit may be damaged due to a matching error. Consult us for system expansion.
<b>Check transducer connection before power ON.</b>	Do not turn the power switch ON when the transducer is disconnected or when it is not inserted into the water. If done, the transducer or transmitter circuit may be damaged.
<b>Always clean the transducer.</b>	Since transducer performance can drop due to the adverse effects of bottom growth, keep the transducer clean. Never paint the transducer surface.
<b>Transducer must be installed by authorized personnel.</b>	Consult us for transducer installation by authorized personnel.





# Important Notice

<b>Manual handling</b>	Keep this manual in a safe place where you can access quickly. This manual must be passed to the new owner of the CHROMASCOPE when it is transferred.
------------------------	---

This is a fish finder/depth finder not a navigator. During navigation, use the correct charts, positioning instrument (such as a GPS receiver) and a depth finder to determine the position, depth, other ship's data, and so on.







## Pictorials

This manual uses the following pictorials for easy understanding of safety instructions. Always follow these instructions carefully.

	<b>WARNING</b>	Always follow this instruction to prevent injury or loss of life.
	<b>CAUTION</b>	Follow this safety instruction to avoid personal injury or damage to your property.
		Symbol $\triangle$ is a CAUTION or WARNING label indicating a safety instruction. (This symbol is an Electrical Shock warning label.)
		Symbol $\otimes$ is an instruction that you must not violate. (This symbol instructs NOT to disassemble the system components.)
		Symbol $\bullet$ is an operation instruction that you must follow. (This symbol shows the main power OFF instruction.)

## **WARNING <For System Operators>**

Always follow this instruction to prevent personal injury or loss of life.

	<b>Turn power OFF during abnormality.</b>	If smoke or a burning smell occurs, a fire or an electrical short circuit may result. Turn the power switch OFF and shut down the power supply immediately. Never try to repair the system yourself. Call for service.
 	<b>Do not open the cabinet.</b>	High voltage may exist in the instrument. Contact with it may cause personal injury or loss of life.
	<b>Do not touch back of the equipment.</b>	Harmful line voltage may be present on the back side of the equipment. Never touch the back side while power is on.
	<b>Avoid excessive shocks to the display unit.</b>	Breaking the display (LCD) can cause personal injury due to flying glass. Care must be taken handling the display to prevent breakage.
	<b>Do not use in poor ventilation.</b>	Make sure the unit has adequate room for ventilation. This space keeps operating temperatures at a safe level.

# Color sounder (chromascope)- How it works-

The color sounder (Chromascope) consists of a display unit and a transducer with specified frequencies (or a transducer with speed/temperature sensor.)

An electronic pulse signal is generated in the transmitter section of the display unit. When coupled to the transducer, this signal is converted into an ultrasonic signal and is transmitted toward the bottom. The Signal travels through the water until it strikes an object or the bottom. It is reflected back, hits the transducer surface, and is reconverted into an electronic signal by the transducer. Then it is amplified in the receiver section, processed in the main logic section, and displayed, as an image on a CRT screen. (Figure 3)

When your boat travels from point A to point B as shown in Figure 1, the beam of the transducer installed on your boat shows a cross-sectional view in the water.

Figure 2 indicates a cutaway view under the water when your boat moves from point A to point B.

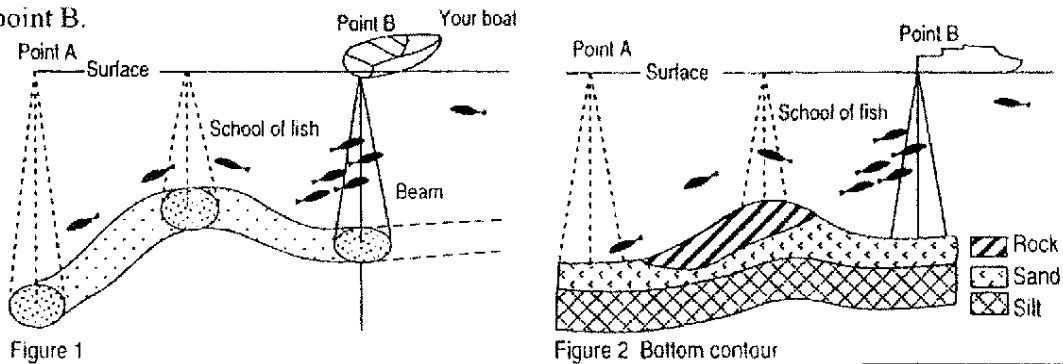

The screen shows the latest scan data at its right position. After the next scan, the previous data is moved to the left and the latest scan data is shown at the right position. When your boat moves from point A to point B, the screen shows the scan data as shown in Figure 3.

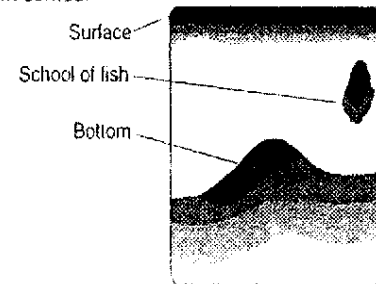
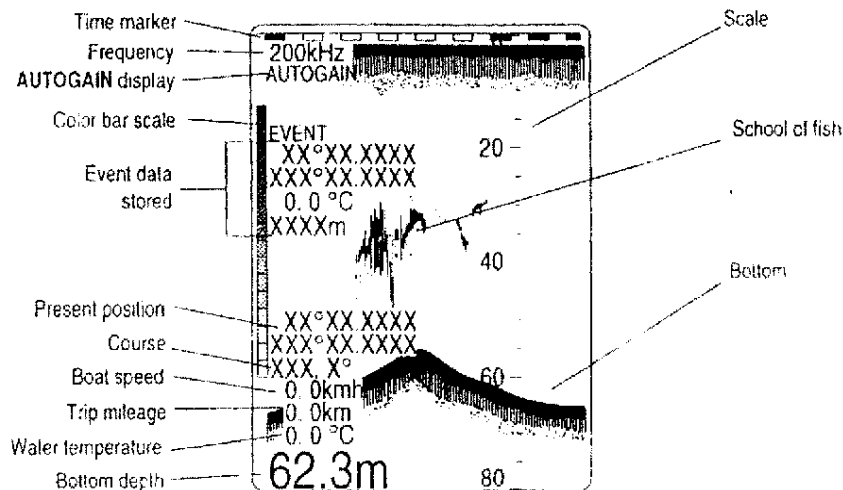

Figure 3

## Image

This example shows all data sets that may be shown on the screen. The actual screen, however, shows part of them according to your operation setup.



# Name

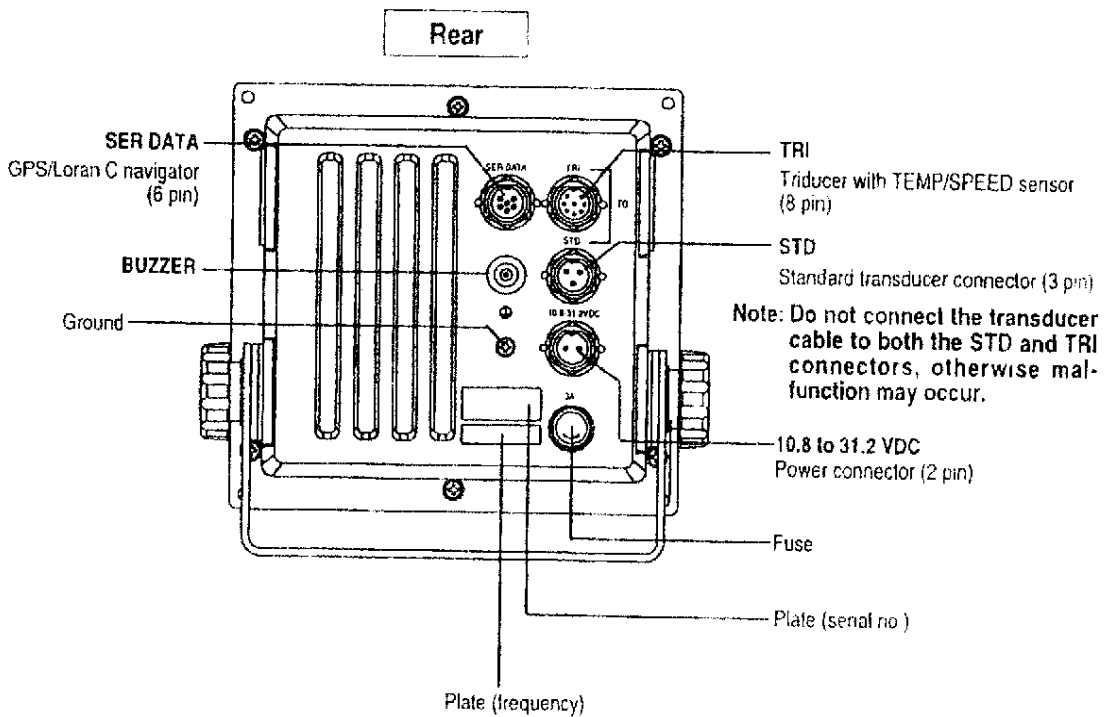
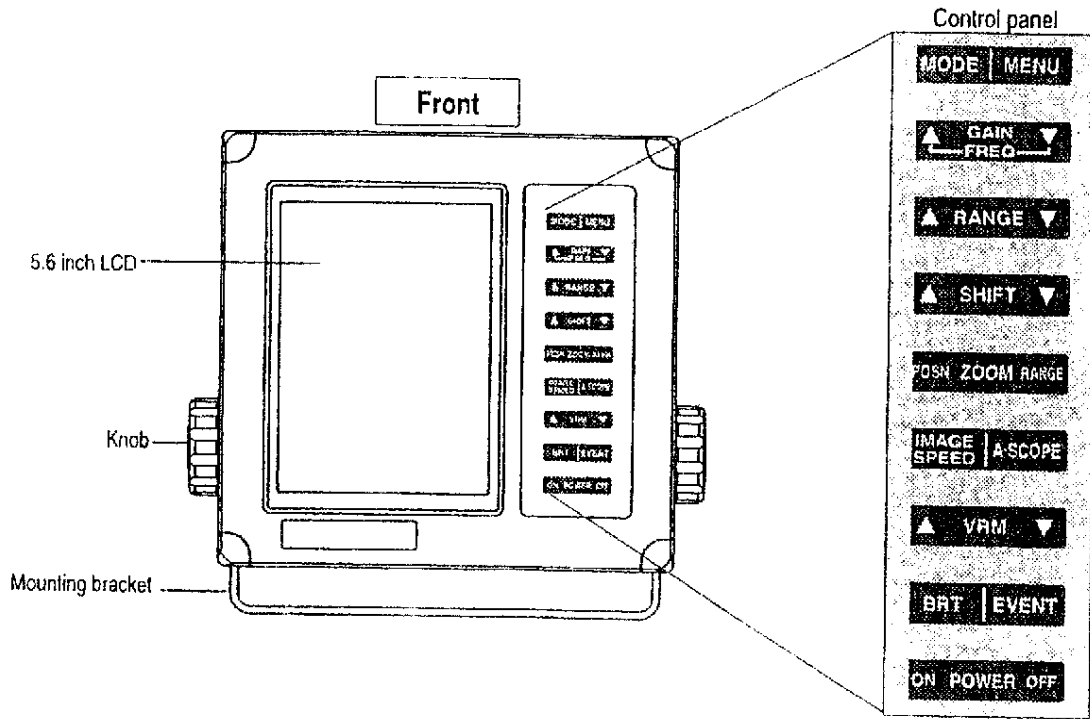

Refer to Plug pin arrangement, page 21

# Getting started

## Displaying the normal image

The normal image consists of two types, the fixed range and auto range. If you select the fixed range, the image is displayed on the screen within the extent between water surface and the predetermined range (depth). In the auto range, on the other hand, sea bottom is constantly kept on the screen and if water depth changes, the range is automatically switched accordingly.

### 1 Turning power on

**ON POWER OFF**

Press ON to turn the power on.

**POWER OFF:**  
Hold down the OFF side of the key until display on the screen disappears

200kHz  
50kHz  
RDW No. KM-D1233  
SELF CHECK COMPLETED

200kHz  
AUTO GAIN

20  
40  
60  
80

62.3m

After 15 seconds, image comes out from the right end of the screen.

### 2 Adjusting screen brightness

CRT BRIGHTNESS

Brightness level selected

40

**BRT** **EVENT**

Press to display the word CRT BRIGHTNESS.

CRT BRIGHTNESS

40

**BRT** **EVENT**

While the word is indicated, press repeatedly to a desired screen brightness.

**BRT** Every press changes the 6 brightness levels in the following rotation.  
Brightest → Darker → Darkest

### 3 Selecting the range (depth range)

RANGE

AUTO

80

**▲ RANGE ▼**

Press either ▲ or ▼ arrow to display the word AUTO RANGE or RANGE and its setting level on the screen.

RANGE

160 m

160

**▲ RANGE ▼**

While the word is indicated, press either ▲ or ▼ arrow repeatedly to select best suited range

**ARROW**  
 ▲: Decreases the range scale.  
 ▼: Increases the range scale

**MANUAL RANGE selection**  
 Every press changes the range to next level. However, the change from AUTO RANGE selects the number which is close to the depth at the time of switching on

m / ㄆ.ㄆ/m / 1 fm
 AUTO ◀ 5 ▶ 10 ▶ 20 ▶ 40 ▶ 80 ▶ 120 ▶ 160 ▶ 240 ▶ 320 ▶ AUTO  
ft
 AUTO ◀ 10 ▶ 20 ▶ 40 ▶ 80 ▶ 160 ▶ 320 ▶ 480 ▶ 640 ▶ 1280 ▶ AUTO

**AUTO (auto range)** This image is constantly displayed between water surface up to the bottom on the screen.

#### 4 Adjusting gain

1. Adjust the gain so that the bottom surface is displayed in the strongest echo color and the color becomes weaker the higher it goes on the screen. Use care so that the strongest echo color may not cover an excessively wide area.
2. The display color can be affected by magnitude of signals reflected by schools of fish and others. The bottom surface may not be displayed with the strongest echo color when the bottom is very deep or made of soft soil.
3. Make sure to adjust the gain so that schools of fish alone may be clearly displayed without allowing noises to appear on the screen.

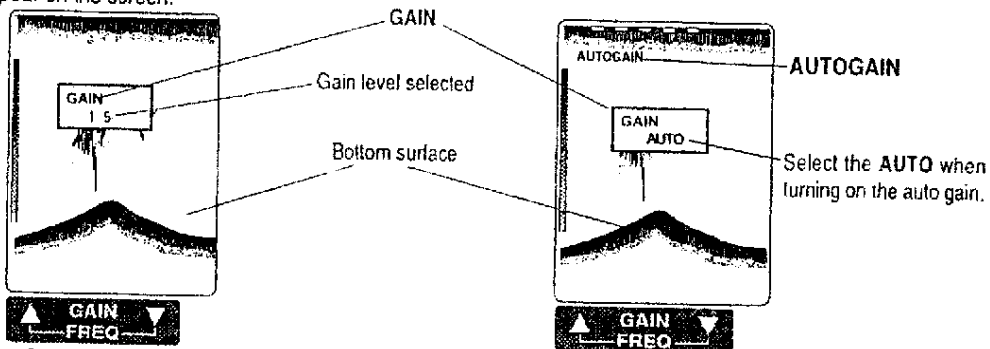

Press either ▲ or ▼ arrow to display the word GAIN and its gain level.

While the word is indicated, press either ▲ or ▼ arrow until the bottom surface is displayed in the strongest echo color

#### GAIN level

Pressing the key sequentially increases the gain in 20 steps from the lowest to the highest level. If you keep on pressing the key after the highest level is reached, the gain returns to the lowest automatic gain level as shown below.

AUTOGAIN ◀ Minimum (1) ↔ Maximum (20) ▶ AUTOGAIN  
 AUTOGAIN: Constantly provides an optimum echo color display

#### Gain Control by Frequency Level

When high frequency images alone are on the screen, you can adjust high frequency gain. Likewise, when low frequency images alone are displayed, adjustment of low frequency gain is available. When both high and low frequency images are displayed in parallel, pressing both sides of the key allows you to select the frequency you want to adjust. If you set any of high and low frequency to the auto gain, the other is also set to the auto. And, if the auto gain of one of the two frequencies is reset, the auto gain being set on the other is also reset.

#### 5 Selecting image speed

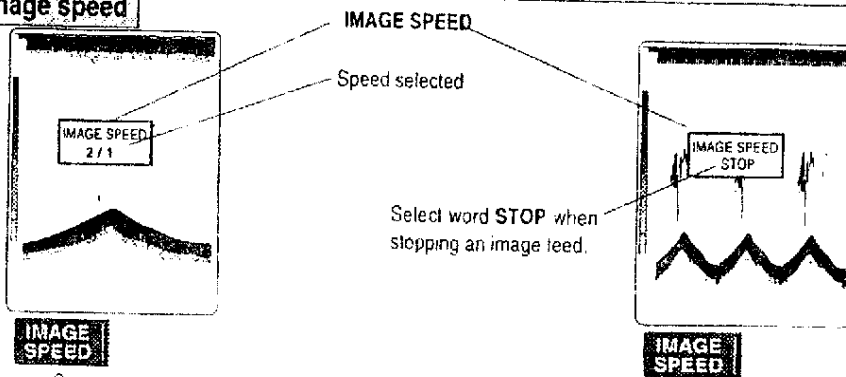

Press to display the word IMAGE SPEED

While the word is indicated, press for a proper speed for your particular application.

#### IMAGE SPEED rotation

Every press changes speed in the following rotation.

Fastest ▶ 2/1 ▶ 1/1 ▶ 1/2 ▶ 1/4 ▶ 1/8 ▶ STOP ▶ Slowest

#### Relationship Between Feed Rate and Transmission Count

Feed count/transmission count is the relationship existing between them. For example, 2/1 indicates that images are fed 2 times into left per transmission and 1/4 means that images are fed 1 time into left per 4 transmissions.



## Shifting the depth range

The normal image consists of two types, the fixed shift and auto shift. If you select the fixed shift, the image is displayed on the screen within the extent between the predetermined depth (Shift position) and the also predetermined range. In the auto shift, on the other hand, sea bottom is constantly on the lower part of the screen and if water depth changes, the image is automatically shifted to the direction of depth change.

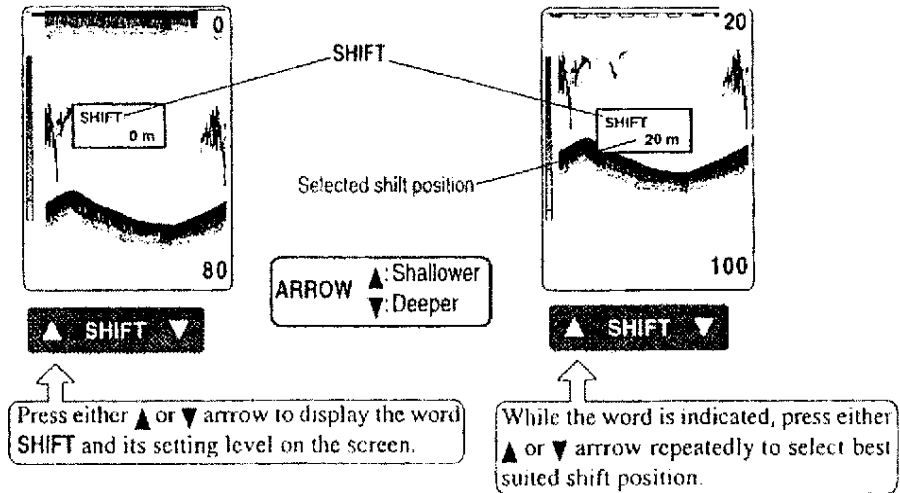

## Shifting the depth range

Pressing the **▲ SHIFT ▼** key sequentially switches the shift value by one unit (when the metric unit is employed, pressing the key once increases or decreases the value by 1 meter). When you move into the fixed shift from the auto shift, however, shifting starts from the value being set in the auto shift mode.

Autoshift ◀ 0 ↔ Maximum depth range

## Selecting the Auto Shift

The auto shift mode constantly displays the sea bottom at the bottom of the screen.

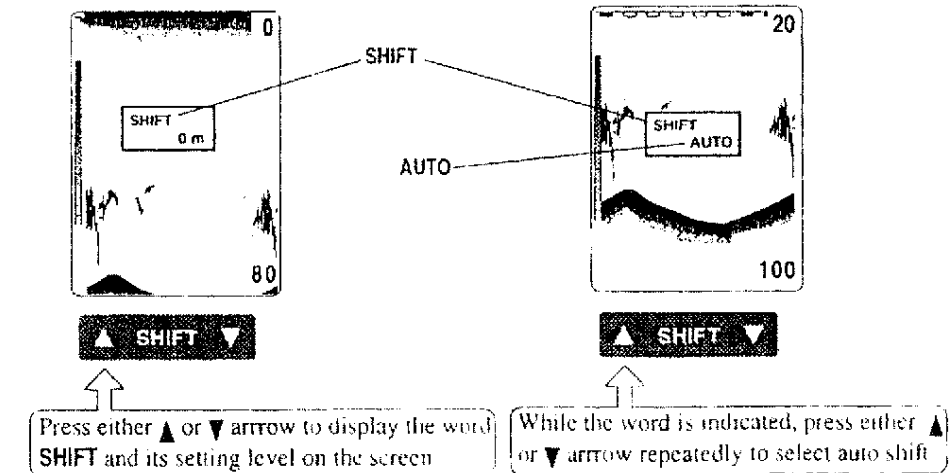

**Note** You cannot select the auto shift as long as the auto depth range is turned on

# Selecting multiple image

Pressing the **MODE** key changes the screen in the following sequence.

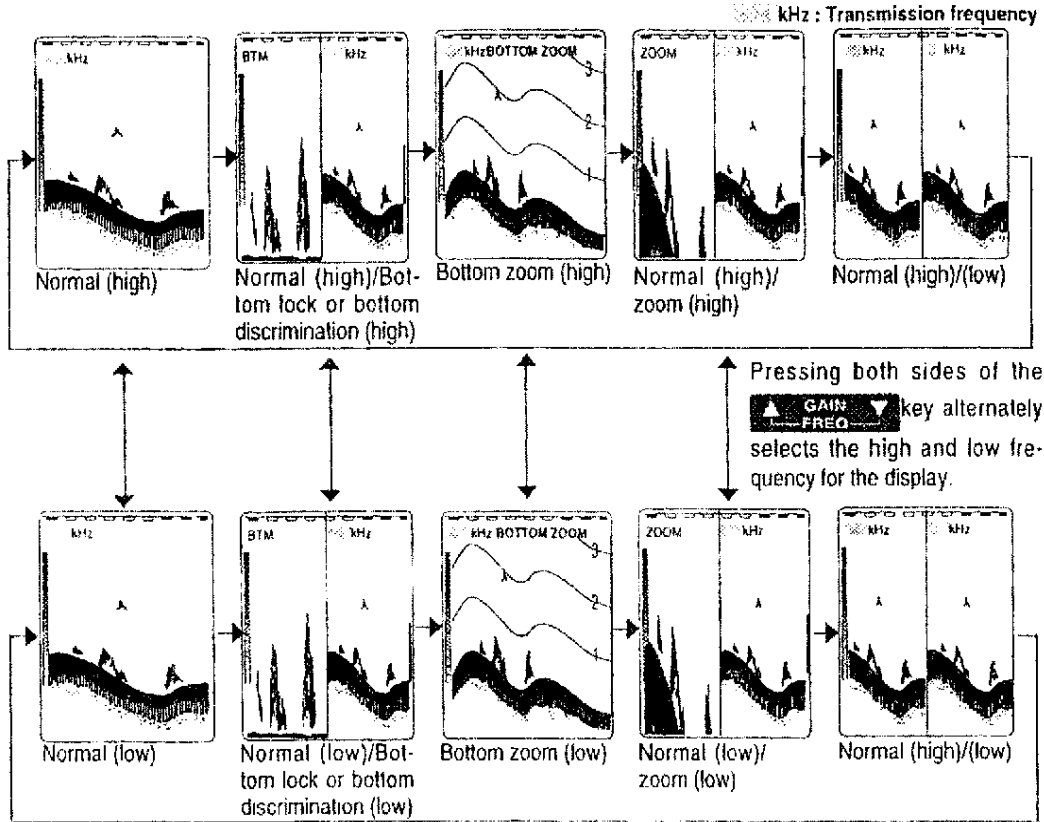

Switching between the bottom lock and bottom discrimination image	This switching is available from the INITIAL MENU 1/2 "BTM/B.D. SELECTION".
Switching Between the Vertical and Horizontal Screen Split	This switching is available from the INITIAL MENU 1/2 "DISP. LAYOUT"

# Displaying the zoom image

The zoom function allows you to view a desired image in an enlarged size. Two types of zoom images are available. One is the partial zoom which provides an enlarged image of the pre-specified range and the other is the bottom zoom in which the bottom is constantly displayed on screen. The bottom zoom comes in three styles, namely the fixed bottom zoom, bottom quality zoom and partial bottom zoom.

## Switching the zoom range

Using the **MODE** key allows you to zoom up any of the following zoom images.

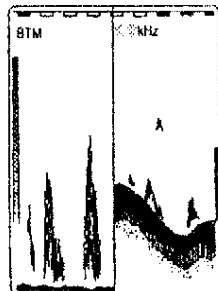

Normal/Bottom lock or bottom discrimination

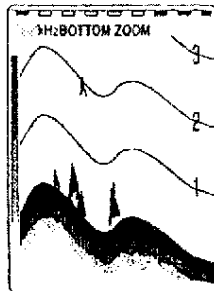

Bottom zoom

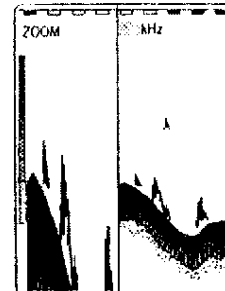

Normal/zoom

Switching between the bottom lock and bottom discrimination image

This switching is available from the INITIAL MENU 1/2 "BTM/B.D. SELECTION".

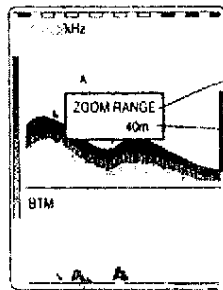

**POSN ZOOM RANGE**

ZOOM RANGE

Selected zoom range  
Presented zoom range

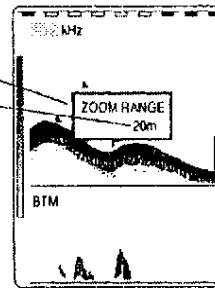

**POSN ZOOM RANGE**

ZOOM RANGE mark  
The zoom range is indicated by an orange bar.  
Bottom lock image  
Bottom discrimination image  
Zoom image

Press to display the word ZOOM RANGE and its setting.

While the word is indicated, press repeatedly to select zoom range.

Pressing the **ZOOM RANGE** key sequentially changes the zoom range as shown below.

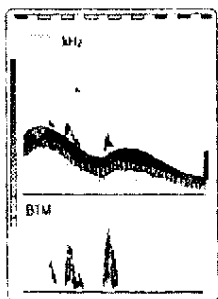

A 1/8 space of a depth range in the normal image is enlarged into full size of the zoom image screen.

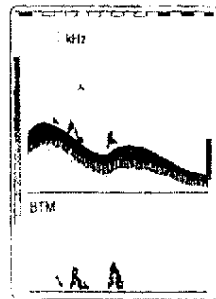

A 1/4 space of a depth range in the normal image is enlarged into full size of the zoom image screen.

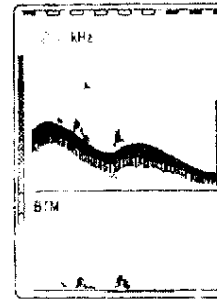

A 1/2 space of a depth range in the normal image is enlarged into full size of the zoom image screen.

## Switching the zoom position

Pressing the **MODE** key sequentially changes the zoom image.

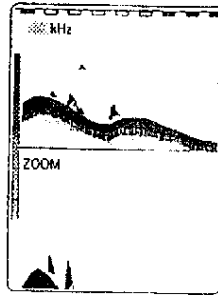

Normal/Zoom

**Note** This switching is not available when the bottom lock, bottom discrimination or partial bottom zoom is turned on because the zoom position is used as reference of the bottom.

**Zoom Position** It refers to the surface side of the zoom range, namely the position from where the zoom starts.

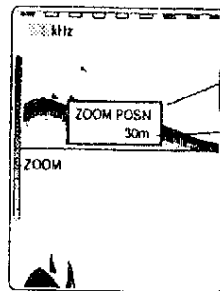

**POSN ZOOM RANGE**

Press to display the word **ZOOM POSN** and its setting

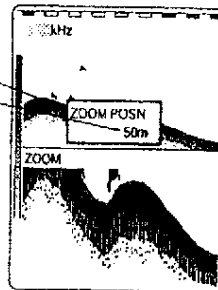

**POSN ZOOM RANGE**

While the word is indicated, press repeatedly to select zoom range.

Pressing the **posn zoom** key sequentially changes the zoom position as shown below.

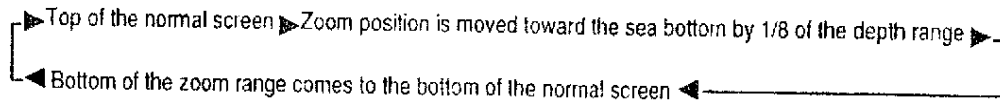

## Relationship between Zoom Range/Zoom Position and Depth Range/Shift

Changing the depth range or shift position does not change the zoom range or zoom position being previously set. If you change the zoom range or zoom position using the Zoom Range key or Zoom Position key, this change is implemented using the currently selected depth range or shift position as the reference. If, in this case, the zoom range or zoom position is out of the screen, zooming is executed using the top of the normal screen as the zoom position.

## Turning on or off display of the A-scope

This function is used for displaying the fish image in A-scope so that you may quickly identify movement of the target fish.

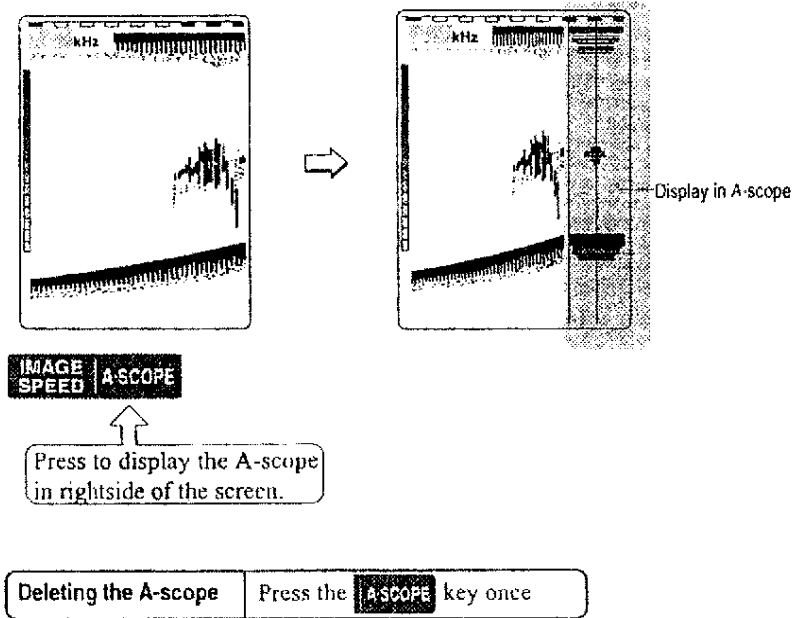

## Measuring depth by VRM (green)

By moving the VRM (green) up and down to a target, such as a school of fish on the screen, the depth of the target can be obtained.

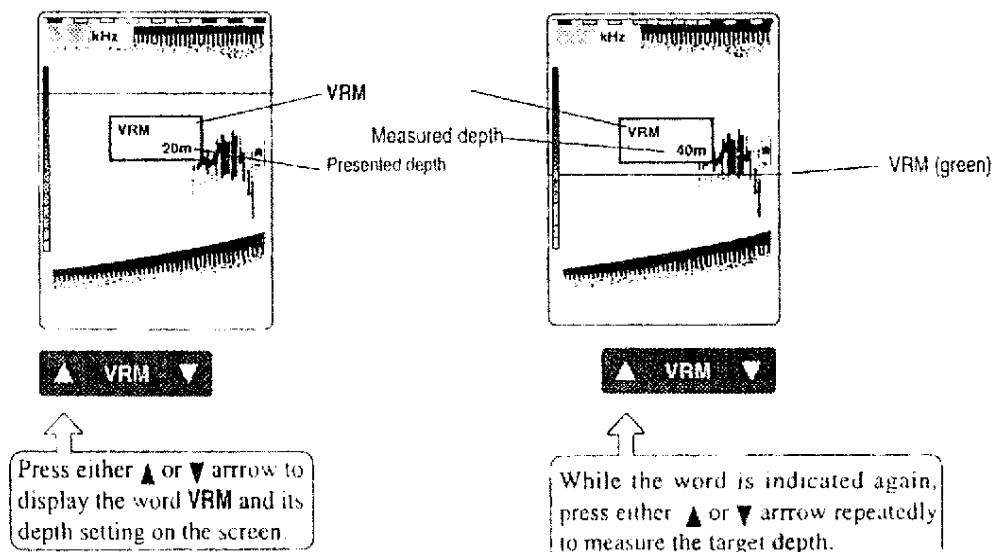

## Storing event data

The following event data is storable by pressing the **EVENT** key.

**Boat position** ..... Position data from the connected navigation system is stored.

**Bottom depth** ..... Bottom depth is stored.

**Water temperature** ... Water temperature is stored. Before it can be stored, water temperature data must be entered externally or from the water temperature sensor (option).

The event data stored is also recalled in blue numerals and words on the screen by pressing the **EVENT** key again.

### Storing

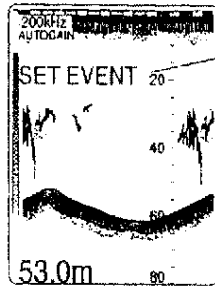

SET EVENT

**BRT** **EVENT**

### Recalling

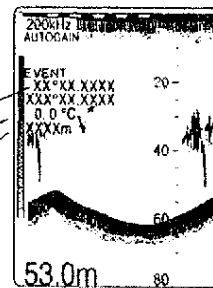

Data stored  
Boat position  
Water temperature  
Bottom depth

**BRT** **EVENT**

Press to display the words **SET EVENT** on the screen, and the event data is stored in the memory. The stored data is displayed in the lower left corner of the screen

Press to remove the data from the screen. For recalling the data, press the key again.

#### Storing new event data

You can store only a single set of event data. Before storing a new set of event data, you must delete the currently stored one using the **EVENT DATA CLEAR** of the menu (3/3 page).

# Menus

## Type of menu

CHROMASCOPE has the following menu's : INITIAL MENU (1/2 and 2/2 pages), MENU (1/3, 2/3 and 3/3 pages) consisting of five different screens.

### Calling the menu

#### Initial menu

Press the **ON POWER** key while holding down the **MENU** key.

Note 1: When power is turned on, turn it off once before calling the menu

2: If you turn power on while depressing the Screen Mode key, the Test menu will appear. This is the menu for adjustment, so press the Screen Mode key again to exit from this menu.

Press the **MENU** key.

Pressing this key alternately displays 1/2 and 2/2 page of the Initial Menu.

#### Menu

Press the **MENU** key while the fish finding screen is turned on.

Pressing this key sequentially displays 1/3, 2/3 and 3/3 page of the Menu.

### Menu and key function

Each item on the screen can be operated by the right or left portion of each corresponding key. Selection is shown by yellow character.

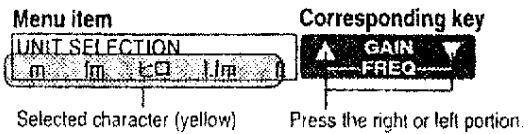

### Returning to display mode

Press **MODE** to return to graphic screen.

### Opening INITIAL MENU 1/2

Following operations are available from the Initial Menu 1/2:

1. Selecting unit of measure
2. Selecting the bottom zoom
3. Matching to the boat draft
4. Switching the split screen layout between horizontal and vertical display
5. Peak hold
6. Simulated picture
7. Selecting a display language

INITIAL MENU 1/2	EXIT	2/2
UNIT SELECTION m fm ㇇ ㇈ 1.m ft		
BTM/B.D. SELECTION BTM B.D.		
DRAFT (0.0~5.0m) 0.0m		
DISP LAYOUT ㇇ ㇈		
PEAK HOLD OFF ON		
SIMULATOR ON		
LANGUAGE (言語選択) ENGLISH (英) JAPANESE (和)		

### Selecting unit of measure

UNIT SELECTION  
m fm ㇇ ㇈ 1.m ft

▲ GAIN ▼  
FREQ

The unit of measure for depth is selectable from: m(meters)/fm(fathoms)/㇇ (japanese hiro)/1.m(Italian fathoms)/ft(feet)

### Selecting the bottom zoom

BTM/B.D. SELECTION  
BTM B.D.

▲ RANGE ▼

You can select a desired bottom zoom type from the following two

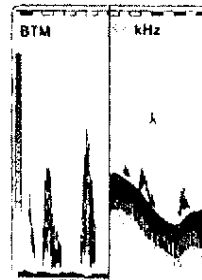

BTM  
(Bottom lock image)

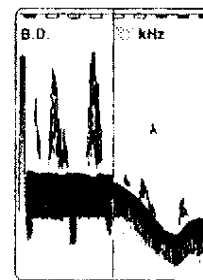

B.D.  
(Bottom discrimination)

### Matching to the boat draft

DRAFT (0.0~5.0m)  
0.0m

▲ SHIFT ▼

This function is used for matching the depth of the emission line to the draft of your boat

## Switching the split screen layout between horizontal and vertical display

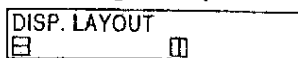

**POSH ZOOM RANGE**

You can select the horizontal or vertical layout for displaying the split screen image.

## Switching the peak hold

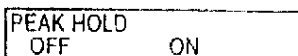
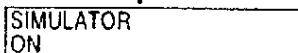

**IMAGE SPEED ASCOPE**

Peak Hold :

A video processing method, which compares the echoes generated from two consecutive transmissions and outputs the largest echo signal.

## Simulated picture



**VRM**

The simulator allows you to utilize functions of the devices that are not actually equipped on your boat.

Execute from simulated picture Turn power on again pressing the **ON POWER OFF** key.

## Selecting a display language

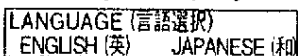

**BRT EVENT**

This key allows you to select a desired language between Japanese and English.

## Opening INITIAL MENU 2/2

Following operations are available from the Initial Menu 2/2:

1. Correcting the sonic velocity.
2. Selecting the boat speed data source.
3. Correcting the displayed boat speed.
4. Selecting the water temperature data source.
5. Correcting the displayed water temperature.
6. Selecting the input data format.
7. Selecting the gain type.

INITIAL MENU	EXIT	1/2
2/2		
SONIC CORR. (-7~+2%)		
0%		
SPEED DATA		
INTERNAL	EXTERNAL	
SPEED CORR. (-50~+50%)		
0%		
TEMP DATA		
INTERNAL	EXTERNAL	
TEMP CORR. (-9.9~+9.9°C)		
0.0°C		
FORMAT		
0182	0183	COMPASS
GAIN TYPE		
LINEAR	106	

## Correcting the sonic velocity

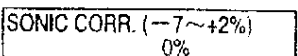

**GAIN FREQ**

A true depth of water can be distorted by water temperature or salt concentration at the time of measurement. In such case, you can use this function to correct the measurement and display the known depth.

## Selecting a boat speed data source

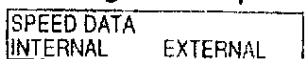

**RANGE**

**TRI** and **SER DATA** connector are provided on the rear side of the incoming signal indicator unit. Both connectors accept boat speed data. When collecting the data from **SER DATA** connector, you need to select a proper input data format referencing the "Selecting an input data format".

**INTERNAL** ..... This mode is used for collecting boat speed data from the water temperature/speed sensor **ST-80/90/100** connected to **TRI** connector. If the boat speed data is absent, "0.0" appears in the data display space.

**EXTERNAL** ..... This mode is used for collecting boat speed data from the speed sensor connected to **SER DATA** connector. If the boat speed data is absent, "X.X.X" appears in the data display space.



## Correcting a displayed boat speed

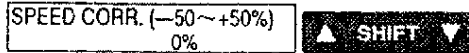

When the water temperature/speed sensor **ST-80/90/100** is connected, you can correct currently displayed boat speed data.

## Selecting a water temperature data source



**TRI** connector and **SER DATA** connector are provided on the rear side of the incoming signal indicator unit. Both of them accept water temperature data. When acquiring the data from **SER DATA** connector, you must select a proper input data format referencing the "Selecting an input data format".

**INTERNAL** ..... This mode is used for collecting the water temperature data from the water temperature/speed sensor **ST-80/90/100** connected to **TRI** connector. If the water temperature data is absent, "0.0" appears in the data display space.

**EXTERNAL** ..... This mode is used for collecting water temperature data from the water temperature sensor connected to **SER DATA** connector. If the water temperature data is absent, "X.X.X.X" appears in the data display space.

## Correcting a displayed water temperature

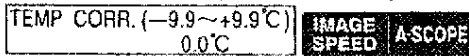

When the water temperature/speed sensor **ST-80/90/100** is connected to **TRI** connector, you can correct currently displayed water temperature data.

## Selecting an input data format

When acquiring data from the GPS navigation system or electronic compass via the **SEA DATA** connector, input data must have one of the following formats.



**0182** ..... Acquires data on the current position (latitude and longitude) in the NMEA-0182 format.

**0183** ..... Acquires data on the current position (latitude/longitude or LOP), bearing of your boat (VTG sentence), external boat speed and external water temperature in the NMEA-0183 format.

**COMPASS** ..... Acquires data on bearing of your boat (HDM sentence) in the NMEA-0183 or DC400 format.

For the data (sentence) entered in the NMEA 0183 format, refer to the "NMEA 0183 output data format Ver. 1.5/2.0".

If the data does not contain a sentence or you cannot receive the data, **XXXX** will appear in the data display space.

If the navigation system or electronic compass is not equipped, data won't be displayed even if you may specify the format.

## Selecting gain type

For general applications where bottom depths are continually changing, set the gain type to **106** (default value). For consistent shallow water use (under 50 feet) select linear type (**LINEAR**).



**LINEAR** ..... Gain changes linearly by the gain number.

**106** ..... Gain changes logarithmically by the gain level number (CVS-106)

## MENU 1/3

The following operations are available from 1/3 of the Menu:

1. Adjusting the operation panel keys brightness.
2. Turning on or off the enlarged display of characters.
3. Eliminating interfering images from other boats.
4. Displaying the white line on the bottom surface.
5. Deleting unnecessary display colors.
6. Selecting a bottom detecting depth.
7. Selecting a sending pulse width.

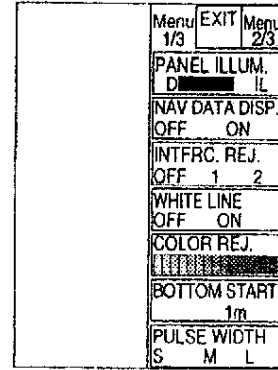

### Adjusting the operation panel illumination



This function allows you to adjust illumination of the operation panel when required.

### Turning On or Off the enlarged Character Display

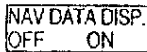

Turning the enlarged character display provides enlarged display of your current boat position, bearing of your boat, boat speed, trip mileage and water temperature.

### Deleting interferences from other boats

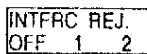

If nearby boats use a fish finder of the same frequency and emission rate, interfering images may appear on the screen as shown in the figure below. This function allows you to delete such images.

Interfering images

Fish image

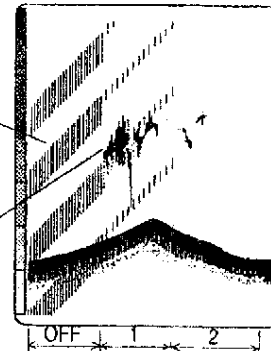

If noise is not displayed on the screen, select OFF to display proper image

### Displaying the white line on the bottom surface



This function shows a specific range from the bottom surface in white so that you may identify schools of fish in deep water more easily.

White line



## Eliminating undesired colors



Noise interference can be displayed on the screen in pale blue, white or pale green. You can eliminate such noise by sequentially deleting the display colors starting with left side. You can check changes in the display colors from the rainbow pattern that appears on the left side of the fish finding screen.

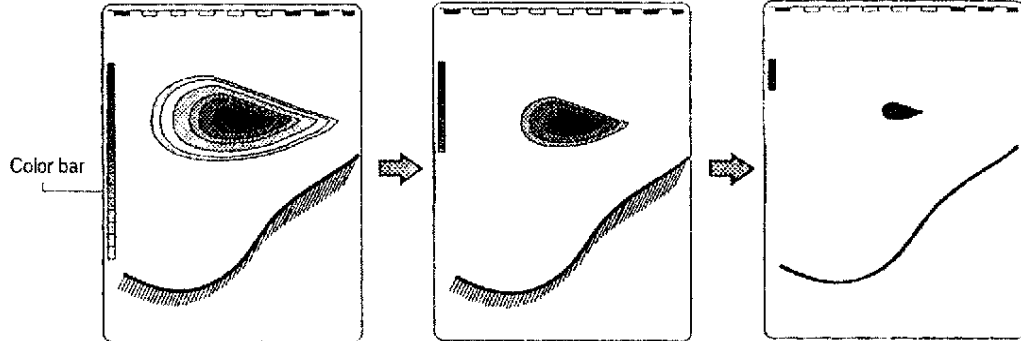

## Specifying a depth for the bottom detection



This function avoids mistaken bottom from schools of fish by setting the inhibit depth for bottom detection.

## Changing the output pulse width



You can specify output pulse width from the Short, Medium and Long.

- S (Short)** ..... Selecting the Short increases the fish image resolution, though it reduces the maximum usable depth for fish finding.
- M (Medium)** ..... Fish image resolution and fish finding depth available from this width are in between that provided by the Short and Long width.
- L (Long)** ..... This width increases the fish finding depth at the expense of the fish image resolution.

# MENU 2/3

The following operations are available from 2/3 of the Menu:

1. Selecting the color tone of the screen.
2. Changing brightness of the background color.
3. Selecting OFF, Bottom or School of Fish for the alarm.
4. Selecting an upper alarm limit.
5. Selecting a lower alarm limit.
6. Changing a magnitude of the signal for activating the fish finder alarm.
7. Changing size (length) of school of fish for activating the fish finder alarm.

Display when selecting the FISH alarm.

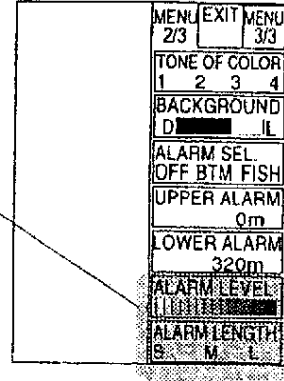

## Selecting a color tone for the image display

**1** TONE OF COLOR 1 2 3 4 **▲ GAIN ▼** **▼ FREQ ▲** Four sets of color tones are usable on the screen.

- 1 ..... 16-color display with blue background.
- 2 ..... 16-color display with dark blue background.
- 3 ..... 16-color display with green background.
- 4 ..... 8-color display with blue background.

## Changing the background color

**BACKGROUND** D █ █ █ █ IL **▲ RANGE ▼** Use this function, for instance, when the screen is too bright in the night time operation.

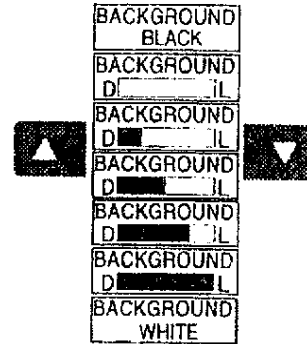

## Turning on or off the alarm, and selecting the bottom or fish alarm

**ALARM SEL** OFF BTM FISH **▲ SHIFT ▼**

- OFF ..... The alarm function is not available
- BTM (Bottom) ..... The alarm is activated if the bottom moves out of the depth enclosed by the upper alarm and lower alarm.
- FISH ..... The alarm is activated if the fish image with the previously specified color and length appears within the upper alarm and lower alarm depth.

## Selecting an upper depth limit for the alarm

**UPPER ALARM** 0m **POSN ZOOM RANGE** It is used for selecting the upper depth limit for activating the alarm. For the upper depth limit, refer to the section on "Setting the bottom alarm" or "Setting the fish alarm".

## Selecting a lower depth limit for the alarm

**LOWER ALARM** 320m **IMAGE SPEED** **A-SCOPE** It is used for selecting the lower depth limit for activating the alarm. For the lower depth limit, refer to the section on "Setting the bottom alarm" or "Setting the fish alarm".

## Setting the magnitude (Color) of fish image signal for activating the fish alarm

You can set a magnitude of fish image signal for activating the fish finder alarm. The alarm is activated when schools of fish having the magnitude (color) of the signal indicated in the left most part comes inside the specified depth range.

Pressing the key increases the alarm level toward left



Pressing the key decreases the alarm level toward right

Note: This setting is available only when the fish alarm is turned on.

## Setting a size (Length) of schools of fish for activating the fish alarm

You can select one of the three sizes (length) of schools of fish for activating the fish finder alarm. Note that the size you selected may or may not activate the alarm depending on depth of water. You are advised to try several sizes until an optimum value is found.



S : Small fish finder  
M : Middle fish finder  
L : Large fish finder

Note: This setting is available only when the fish alarm is turned on.

## Setting the bottom alarm

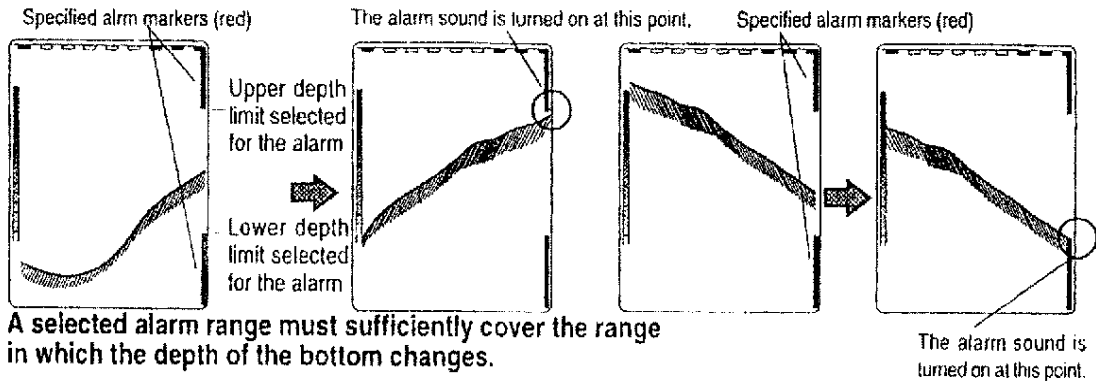

## Setting the fish alarm

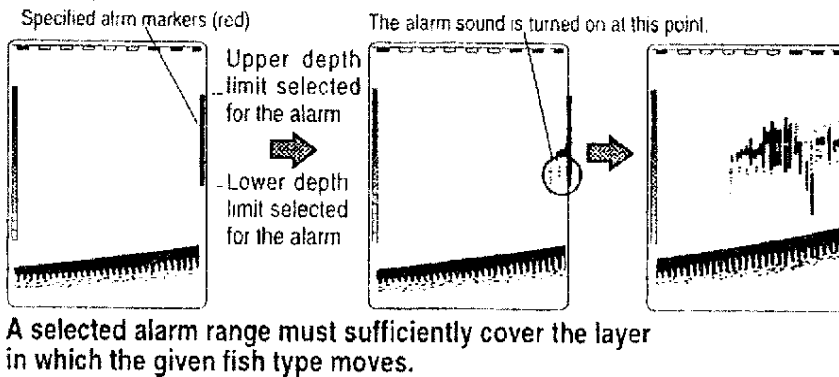

### Precautions on the Use.

- If overlapping between the alarm mark and the fish or bottom image is lost, the alarm is automatically stopped.
- If the alarm mark disappears from the screen, the alarm function is stopped.
- If the alarm mark disappears from the screen in the Short Image mode, the alarm function is stopped.
- If an identical value is selected for the upper and lower alarms, the alarm function is stopped.

### Stopping the alarm sound

Pressing the **BRT** key stops the alarm sound, but the alarm function is automatically set again

### Cancelling the alarm

Select OFF in the MENU 2/3 "ALARM SEL."

## MENU 3/3

The following operations are available from 3/3 of the Menu:

1. Adjusting performance of the auto gain.
2. Displaying current position by connecting the navigation system.
3. Changing the boat speed unit
4. Changing the temperature unit.
5. Resetting the trip mileage.
6. Deleting the event data (registered contents).

MENU	EXIT	MENU
3/3		1/3
AUTO GAIN ADJ.		
0		
POSITION DISP		
OFF LL LOP		
SPEED DISP.		
OFF kmh mph kt		
TEMP DISP.		
OFF C F		
TEMP GRAPH		
OFF ON		
TRIP MILEAGE		
RESET		
EVENT DATA		
CLEAR		

### Adjusting the effect of auto gain

Effect of the auto gain can vary depending on the bottom quality (rocks, sands or seaweed) because it affects intensity of the signals. When the bottom surface does not appear in red, use this function to ensure an optimum auto gain function.



### Displaying boat position when a navigator is interfaced

When the GPS or Loran-C is installed and the "FORMAT" selected from the INITIAL MENU 2/2, you current position can be displayed in latitude and longitude or LOP (Loran-C) value. Display of bearing of your boat is available, too.



— Loran C LOP's  
— Latitude/longitude

When position data is not necessary or no navigator is connected,

Water temperature graph  
Present position  
(Latitude/longitude)  
Course  
Boat speed  
Trip mileage  
Water temperature

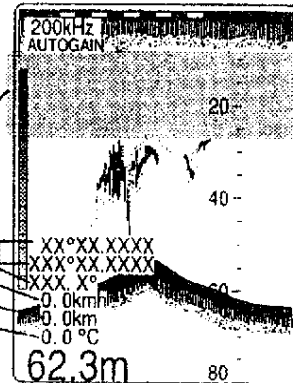

### Selecting unit of boat speed

You can measure the boat speed and trip mileage

when the speed sensor is connected or speed data is externally available.

Before the measurement, you need to specify the unit of the speed. Switching between the internal and external data is done from the INITIAL MENU 2/2 "SPEED DATA".



### Selecting unit of water temperature

Temperature of water surface can be displayed when the water temperature sensor is connected or water temperature data is externally available. Switching between the internal and external data is done from the INITIAL MENU 2/2 "TEMP DATA".



### Turning on or off display of the water temperature graph

Water temperature graph are available on the screen, when the water temperature sensor is connected or water temperature data is externally available.



### Resetting the Trip Mileage

The trip mileage digitally displayed on the screen by entered speed data from speed sensor (internal/external), can be reset by selecting RESET in this parameter. Press ▲ arrow key, and the word RESET will be displayed in yellow and trip mileage will be reset. Once it is reset, the trip mileage starts counting from zero.



### Clearing event data

The event data (bottom depth, water temperature, and boat position) is cleared by selecting CLEAR in this parameter. Press BRT key, and the word CLEAR will be displayed in yellow and event data stored will be cleared. Once it is cleared, new event data can be stored in the echo sounder.

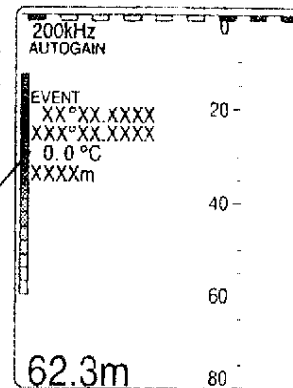

Event data

# Troubleshooting

1. Make sure that the display unit, transducer, and power cable are correctly installed as instructed.
2. Press **POWER ON** key, adjust **GAIN** until the bottom image is displayed in red. Adjust screen **brightness** for comfortable brightness.
3. If nothing happens after turning on, check power cable connection, power cable, fuse, and power source again.
4. If you cannot see your desired image on the screen with the initial setting, reset the **RANGE** deeper and readjust the **GAIN**.
5. If the data indicating functions relative to the TEMP/SPEED sensor, such as boat speed, and water temperature indications, looks incorrect, check TEMP/SPEED sensor of the transducer as well as connection between the unit and the transducer.

# Specifications

## Major Specifications

Specifications subject to change without notice

Output	300 W																						
Display	6-inch color CRT (320 x 240 pixels)																						
Presentations colors	8 colors (red, orange, yellow, green, light green, white, light blue, blue)/back ground color (blue) or 16 colors (8 colors and half tone)/back ground color (blue, dark blue or green)																						
Choice of frequency (kHz)	Dual freq.: 50/200																						
Depth range	5, 10, 20, 40, 80, 160, 320 (Meters, Hiro, Fathoms, Italian Fathoms) or 10, 20, 40, 80, 160, 320, 640, 1280 (feet)																						
Max. depth with shift	Automatic or manual, Max. 640 (Meters, Hiro, Fathoms, Italian Fathoms) or 2,560 (feet)																						
Zoom range/bottom range	1/2, 1/4 and 1/8 of the selected depth range (Meters, Hiro, Fathoms, Italian Fathoms, Feet), Min. 2.5 (Meters, Hiro, Fathoms, Italian Fathoms) or 10 (feet)																						
Zoom position	Settable within the displayed depth range (at an interval of 12.5% of the displayed range)																						
Presentation mode N: Normal or auto range S: Shift or auto shift range B: Bottom lock B.D: Bottom discrimination B.Z: Bottom zoom Z: Zoom	<table border="1"> <tr> <td>N</td><td>S</td><td>N</td><td>S</td><td>N</td><td>S</td><td>N</td><td>S</td><td>B.Z</td><td>N</td><td>S</td> </tr> <tr> <td></td><td></td><td>N</td><td>S</td><td>B</td><td>B</td><td>B.D</td><td>B.D</td><td></td><td>Z</td><td>Z</td> </tr> </table> <p>Vertical or horizontal split screen display is available on the above modes. MENU, A-scope or navigational data display is available in all the above modes except the INITIAL MENU mode. The INITIAL MENU mode is provided for setting initial and other functional parameters.</p>	N	S	N	S	N	S	N	S	B.Z	N	S			N	S	B	B	B.D	B.D		Z	Z
N	S	N	S	N	S	N	S	B.Z	N	S													
		N	S	B	B	B.D	B.D		Z	Z													
Image display area	Vertically divided (top/bottom ratio: 1:1, except bottom lock image 2:1), horizontally divided (left/right ratio is 1:1), MENU (right part: 50%), A-scope (right part: 27%)																						
Audible alarm	Fish alarm and sea bottom alarm																						
Image speed	Fixed 5 speeds (2/1, 1/1, 1/2, 1/4 and 1/8) and STOP																						
Inference rejection	2 levels																						
Color rejection	14 levels																						
Marker	Depth marker (VRM), scale, expanded position marker, division marker, alarm range marker, time marker, color pattern																						
Event memory	1 - depth, water temperature (water temperature data is required, OPTION), boat position (position data is required, OPTION)																						
Other functions	Gain (automatic and manual), panel illumination, draft adjustment, switching of internal/external synchronous signal, pulse length selection, speed compensation, water temperature compensation, external echo sounder connection																						
Navigational data	Boat position (latitude/longitude in 0.001 minute increments, Loran C LOP 0.1 minute increments), water temperature (°C/°F/Graphic display), boat speed (KT/MPH/KMH), trip mileage (NM/SM/KM), boat bearing																						
Input data format	NMEA-0182, NMEA-0183 (GGA, GLL, GNS, GTO, HDM, MTW, VTG), DC400 (HDM)																						
Output data format	NMEA-0183 (DBS, DBT, DPT, MTW, VHW)																						
Power supply	10.8 to 31.2 VDC																						
Power consumption	15 W or less (at 12 VDC)																						
Environmental condition	-15 to +55 °C (5 to 131 °F)																						

\* Built-in or separate TEMP/SPEED sensor, or navigator are required.

## Standard equipment

Article	Type	Remarks	Weight/length	Quantity
Color display unit		With mounting bracket and knobs	2.4 kg (5.3 lb)	1
Transducer		With transducer cable, one end connector		1 set
DC power cable	CW-205-1	With 2-pin connector	2m (6 9/16 ft)	1
Foam	C26MB21154			1
Cover	C26MB21022			1
Fuse	F7161, 3A	For spare		2
Truss tapping screws	TPT5 x 20U	For display unit mounting		4
Operation manual				1

## Outline and dimensions

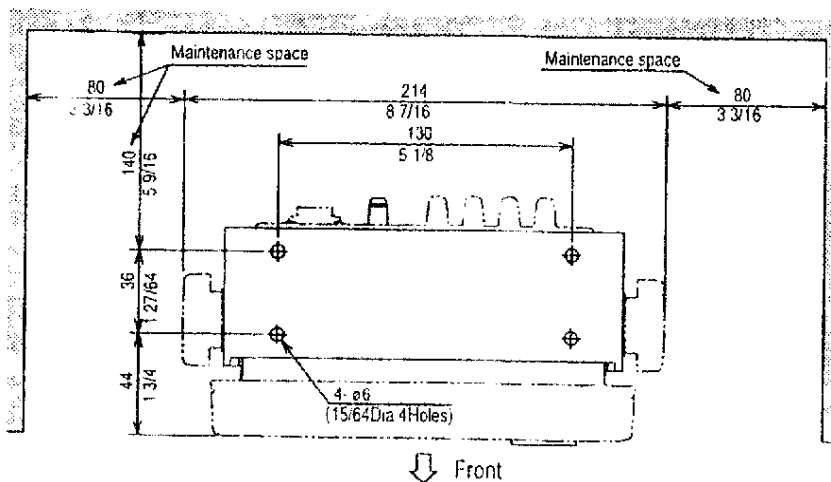
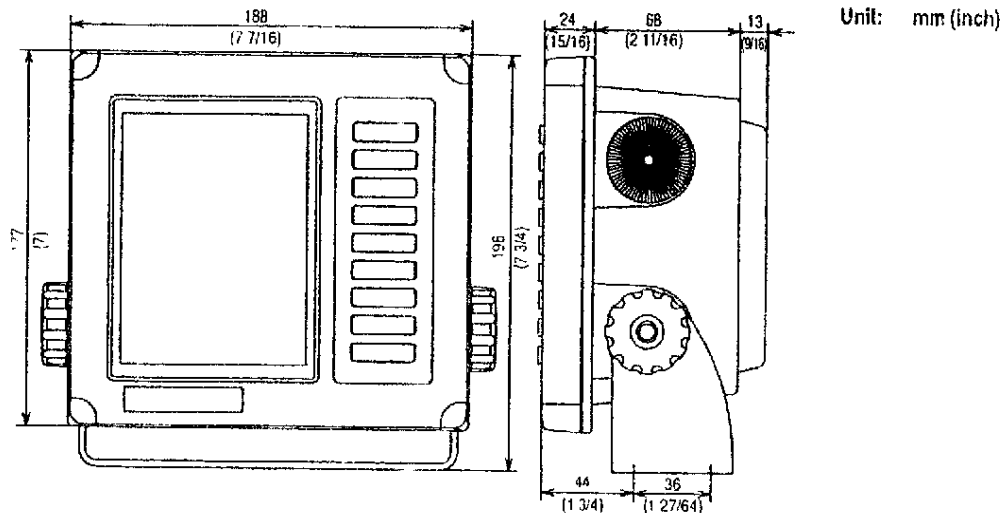



# Installation

## Mounting display unit

The bracket with slot facing toward you should be installed on a flat and solid surface for maximum stability.

Overhead mounting is also possible.

Position the bracket, mark and drill four (4) holes.

Securely screw it.

Place the display in the bracket and secure it to the bracket applying two bracket knobs and washers.

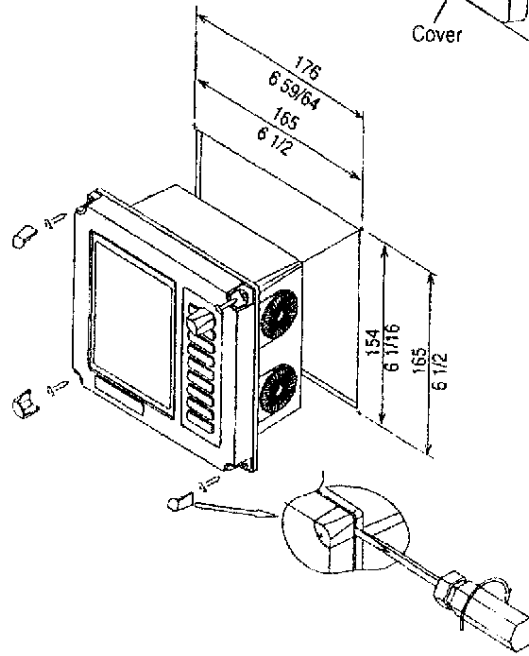
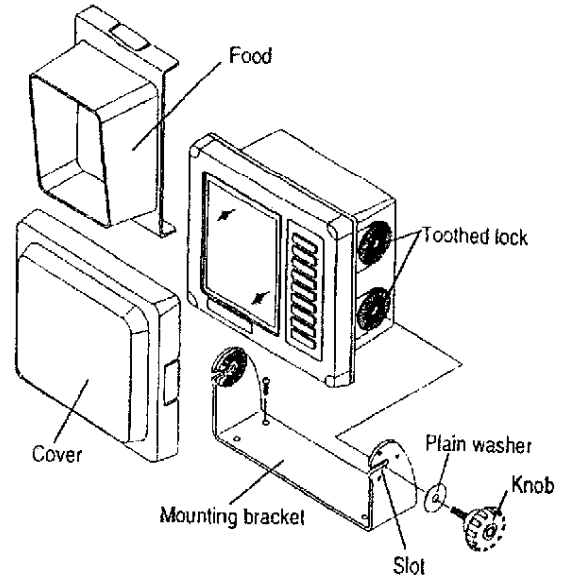

## Plug pin arrangement

Four connectors are mounted on the rear panel including the power connector. The functions and pin arrangements are specified below.

Refer to **Name** page 2.

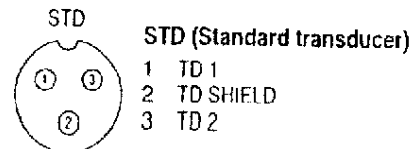
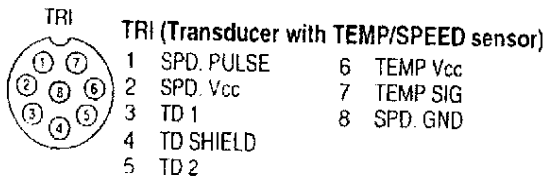
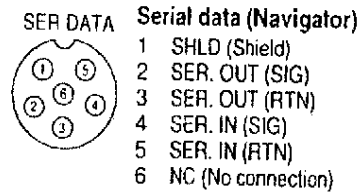
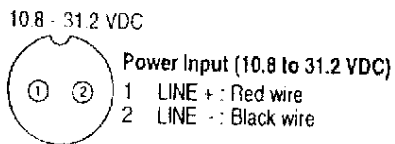

### CAUTION

Be careful with the installation of transducer pins 3 and 5 in TRI (triducer) and pin 1 and 3 in STD (standard transducer) from other pins as **high voltage** is applied to these pins.

# NMEA-0183 output data format Ver. 1.5/2.0

## Data configuration

Parity bit : none

The bit configuration of the byte is as specified below.

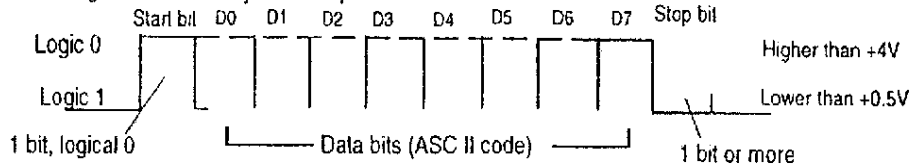

## Data specifications

Baud rate	Output level	Output current	Sentence	Update rate
4800 baud	TTL	Maximum 5 mA	DBS + MTW + VHW + DBT + DPT	4.6 seconds

## Sentence description

Descriptions	Contents of data field <small>Check sum. All data before the asterisk (*) except \$ characters are exclusively ORed and used.</small>
DBS (Ver. 1.5)	<p>Depth below surface</p> <p>\$ - - DBS, xxxx.x, f, xxxx.x, M, xxx.x, F *hh &lt;CR&gt; &lt;LF&gt;</p> <p>Start of sentence      Water depth (feet)      Water depth (meters)      Water depth (fathoms)      Check sum</p> <p>Sentence format      Talker device</p>
DBT (Ver. 1.5)	<p>Depth below transducer</p> <p>\$ - - DBT, xxxx.x, f, xxxx.x, M, xxx.x, F *hh &lt;CR&gt; &lt;LF&gt;</p> <p>Start of sentence      Water depth (feet)      Water depth (meters)      Water depth (fathoms)      Check sum</p> <p>Sentence format      Talker device</p>
DPT (Ver. 2.0)	<p>Depth</p> <p>\$ - - DPT, xxxx.x *hh &lt;CR&gt; &lt;LF&gt;</p> <p>Start of sentence      Offset from transducer (meters)      Check sum</p> <p>Sentence format      Talker device</p> <p>Positive: Distance from transducer to water line. Negative: Distance from transducer to keel.</p>
MTW (Ver. 1.5)	<p>Water temperature</p> <p>\$ - - MTW, xx, C *hh &lt;CR&gt; &lt;LF&gt;</p> <p>Start of sentence      Temperature, degree C      Check sum</p> <p>Sentence format      Talker device</p>
VHW (Ver. 1.5)	<p>Water speed and heading</p> <p>\$ - - VHW, xxx.x, T, xxx.x, M, xx.x, N, xx.x, K *hh &lt;CR&gt; &lt;LF&gt;</p> <p>Start of sentence      Heading      True bearing      Magnetic bearing      Speed (knots)      Speed (km/h)      Check sum</p> <p>Sentence format      Talker device</p>